

VADDIO™ WALLVIEW™ HD-20 DVI/HDMI

High Definition Robotic PTZ Camera Featuring the Quick-Connect™ DVI/HDMI SR Interface and the CONCEAL™ Wall Mounting System

Model Number 999-6956-000 (North America)
Model Number 999-6956-001 (International)



Quick-Connect DVI/HDMI SR Interface

PN: 998-1105-018



Inside Front Cover - Blank

WallVIEW DVI/HDMI HD-20 Overview:

The WallVIEW HD-20 HD PTZ camera and Quick-Connect DVI/HDMI EZCamera™ Cat-5e cabling system using HSDS™, delivers a system that allows for easy installation and integration of a camera system capable of simultaneous HD analog YPbPr and digital (DVI-D or HDMI with adapter cable). The HD-20 camera is built around a 6.49mm diagonal (1/2.8 Type) high-speed CMOS image sensor with a total of 3.27M pixels and a 20x optical zoom lens, making it the ideal choice for a wide range of high definition video applications including, 720p, 1080i or 1080p.

Because the camera module is built around a new, high speed CMOS image sensor with an increased pixel aperture size, high frame rate, high signal to noise, using the column-parallel A/D conversion method, the resolution, saturation and the sensitivity of the sensor is increased. The HD-20 achieves improved picture quality even in low light environments requiring a minimum illumination of just 1.6 LUX.

The 11-element 20x optical zoom lens with HiLD™ (High Index Low Dispersion) Glass allows WallVIEW HD-20 to capture a wide angle of view (55.2° wide end) enough to view everyone at a conference room table, as well as capture an individual from a long distance (2.9° tele end). The zoom range provides greater flexibility for a wide variety of applications. Pan range is +170 to -170 degrees, and Tilt range is -30 to +90 degrees.

The HD-20 is paired with the Quick-Connect DVI/HDMI SR Interface, which provides power to the camera and returns HSDS video from the camera up to 100' (30.5m) over a single Cat-5e cable. The Quick-Connect DVI/HDMI features extended control functions including Daisy Chain Control Emulation (DCCE™), which allows single control port codecs to control multiple HD-20 cameras, and IR forwarding in modulated and non-modulated formats for extending the reach of the IR remotes included with today's most popular videoconferencing systems. The WallVIEW HD-20 is an exceptional camera for a wide range of HD video applications such as houses of worship, corporate boardrooms, live events and distance-learning.

Intended Use:

Before operating the device, please read the entire manual thoroughly. The system was designed, built and tested for use indoors, and with the provided power supply and cabling. The use of a power supply other than the one provided or outdoor operation has not been tested and could damage the device and/or create a potentially unsafe operating condition.

Important Safeguards:

Read and understand all instructions before using. Do not operate any device if it has been dropped or damaged. In this case, a Vaddio technician must examine the product before operating. To reduce the risk of electric shock, do not immerse in water or other liquids and avoid extremely humid conditions.



Use only the power supply provided with the system. Use of any unauthorized power supply will void any and all warranties.



Please do not use "pass-thru" type RJ-45 connectors. These pass-thru type connectors do not work well for professional installations and can be the cause of intermittent connections which can result in the RS-232 control line failing and locking up, and/or compromising the HSDS™ signals. For best results please use standard RJ-45 connectors and test all cables for proper pin-outs prior to use and connection to Vaddio product.



WallVIEW HD-20 PTZ Camera
and CONCEAL Wall Mounting
System

Save These Instructions:

The information contained in this manual will help you install and operate your product. If these instructions are misplaced, Vaddio keeps copies of Specifications, Installation and User Guides and most pertinent product drawings for the Vaddio product line on the Vaddio website. These documents can be downloaded from www.vaddio.com free of charge.

UNPACKING:

Carefully remove the device and all of the parts from the packaging.

Unpack and identify the following parts for 999-6956-000:

- One (1) ClearVIEW HD-20 HD Camera
- One (1) Vaddio IR Remote Commander
- One (1) Quick-Connect DVI/HDMI SR Interface One (1) Laird Technologies 28A2432-0A2 Clamp-on Ferrite Cylinder (Wrap IR forwarding LED wires twice before screwing stripped wire ends to 3 conductor Molex Euro Jack)
- Two (2) Laird Technologies 28A0640-0A2 Clamp-on Ferrite (Clamp around 0.8" diameter DVI Cable at the Quick-Connect DVI end)
- One (1) Laird Technologies HFA163090-0A2 Clamp-on Ferrite (Clamp around 0.8" diameter shielded DVI Cable at the Monitor end)
- One (1) Vaddio PowerRite™ 24 VDC, 2.0 Amp Power Supply
- One (1) 998-1001-232 EZCamera Control Adapter (for control systems)
- One (1) 998-1002-232 EZCamera Control Adapter (for TANDBERG VC systems) One (1) 3-pos Phoenix type connector
- One (1) CONCEAL Wall Mounting System with Mounting Hardware
- One (1) AC Cord Set for North America
- Documentation

(Note: The 999-6956-001 Int'l Version includes the Euro and UK power cables)

ClearVIEW HD-20 PTZ Camera, Front View with Feature Call-outs:



1) Camera and Zoom Lens:

The 20X optical zoom lens is built around a 6.49mm diagonal (1/2.8 Type) high-speed CMOS image sensor with a total of 3.27M pixels for truly precise HD video image acquisition.

2) Red Tally Light:

A red tally light is illuminated when the camera receives a VISCA command from an external control system.

3) IR Sensors:

IR sensors are built into the front of the ClearVIEW HD-20 to receive IR signals from the IR remote control supplied with the camera.

4) Blue Power Light:

A Vaddio blue power light is illuminated when the camera is turned on.

Compatible Vaddio Switchers and Joystick Controllers:



ProductionVIEW™ HD
(999-5600-000)



AutoPresenter
(999-5675-000)



Precision Camera Controller
(999-5700-000)

ClearVIEW HD-20 PTZ Camera, Rear View with Feature Call-outs:



5) RS-232 IN & IR Out:

The RS-232 accepts modified VISCA protocol for camera control, as well as transmits IR signaling received by the IR receivers, which can be transmitted to third party devices.

6) Dip Switch Settings:

Settings for IR remote, baud rate, SD output format, and image flip can be configured on these switches. See page 6 for additional information on switch settings.

7) HD Video Select:

A rotary switch allows the user to choose the component HD output video resolution and format. See page 6 for additional information on switch settings.

8) 12 VDC Input:

Power input for the standard, ClearVIEW HD-20 12 VDC, 3.0 Amp camera power supply.

9) HDMI Output:

The HDMI output feeds out HD digital video only (no copy protect or device communication is included). SD is not supported.

10) YPbPr Output:

Component HD video is fed through the DB-15 connector. YPbPr and HDMI signals are simultaneous. SD is not supported.

11) EZ Power/Video Port:

This RJ-45 connector is only used with the Quick-Connect SR Interface and the Quick-Connect DVI-D/HDMI SR Interface to supply power and return HSDS video from the camera.

12) Slot for Optional Cards:

Optional slot cards can be plugged into the ClearVIEW HD-20 camera (the HD-SDI and the EZIM CCU Slot Cards are available).

Quick-Connect DVI/HDMI - SR Interface I/O Description

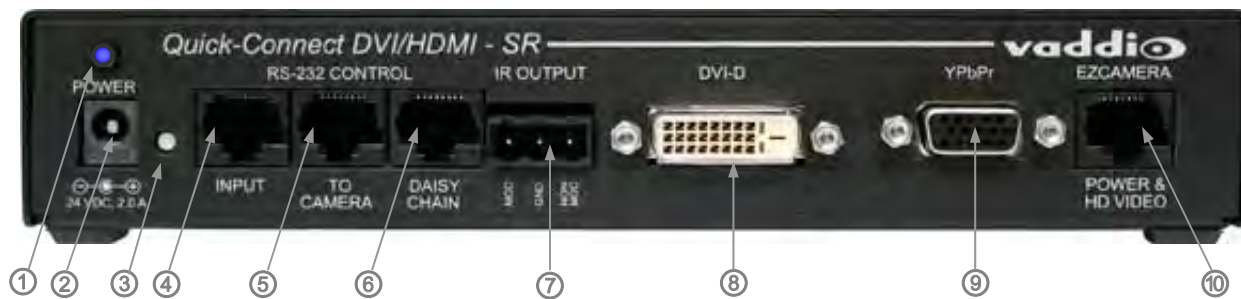

- 1) **Blue LED Power Indicator.**
- 2) **24 VDC Power Port:** Coax Power Connector, 5.5mm OD x 2.5mm ID, Positive Center.
- 3) **Recessed Color Space Conversion Switch:** Toggles between HDMI YCbCr and sRGB (RGBHV) color space. Change the color space to accommodate either YCbCr or RGBHV monitors.
- 4) **RS-232 Control Input** (from joystick controller, codec or control system).
- 5) **To Camera:** RS-232 Control to & from Camera and IR signals returned from the camera.
- 6) **Daisy Chain Control Port:** Daisy Chain Control Emulation (DCCE) output to next Quick-Connect DVI/HDMI SR Interface (does not function with the AutoTrak System).
- 7) **IR Output Port:** Non-modulated (for hard connections) and Modulated for use with IR emitters.
- 8) **DVI-D Output:** High Definition Multimedia Interface (HDMI) Transmitter, HDMI (v 1.3 with deep color) and DVI v 1.0 Compliant - use Recessed Color Space Conversion Switch to toggle between HDMI YCbCr and sRGB (RGBHV) color spaces to suit your monitors
- 9) **YPbPr Output:** Analog Component Video Output on DE-15F (HD-15F) Connector, Resolutions up to 1080p/60 with monitor support.
- 10) **EZCamera Power & HD Video Port:** Supplies power to camera and returns HD video from the camera via Cat-5e. Maximum distance on the CAT-5e cable is 100' (30.5 m).

Installation Basics:

The WallVIEW HD-20 product was specifically designed for installation on a vertical wall surface with Cat-5e cable connectivity for Power, Video and Control signaling (two Cat-5e cables are required). Installation is simplified in that no custom 8-Pin mini-din cables or expensive coax plenum cables are needed and no power outlets are required near the camera bracket. All cabling is routed to the head-end using Cat-5e cables.

Before Installing:

- Locate the camera mounting location paying close attention to camera viewing angles, lighting conditions, possible line of site obstructions, and checking for in-wall obstructions where the camera is to be mounted. Pick a mounting location that will optimize the performance of the camera.
- The CONCEAL Wall Mounting System for the WallVIEW HD-20 can be mounted directly to a 2-gang wall box or can be mounted to the drywall using the supplied four (4) drywall anchors.

RS-232 Cabling:

For RS-232, use a standard Cat-5e cable and RJ-45 connectors (568B termination) from the RS-232 port on the back of a Vaddio camera controller or switcher. If the camera is connected to a third-party control system (such as AMX or Crestron), a DB-9 to RJ-45 control adapter cable is supplied. **Use of pass-thru type RJ-45 connectors is *highly discouraged*.** The Vaddio Cat-5e wiring standard uses pins 7 and 8 on both the video and the control Cat-5e cables. The pass-through connectors have proven to provide insufficient connectivity for these important signals. They are “ok” for voice and data, but not for video and control.

Videoconferencing Codecs and RS-232:

Depending on the codec and RS-232 port used, special DB-9 to RJ-45 adapters may sometimes be required. Refer to Vaddio's price list or website for Tech Notes on the WallVIEW HD-20 page on specific diagrams for wiring the camera to videoconferencing codecs. Any special adapters and configuration information will be noted. **Remember to always power up the cameras before booting up the codec.**

First Things, First...

Using the HD Video Select Rotary Switch and Camera Settings Dip Switch on the back of the camera, set up the camera's output resolution and functional preferences. There is a label on the bottom of the camera that identifies the choices.

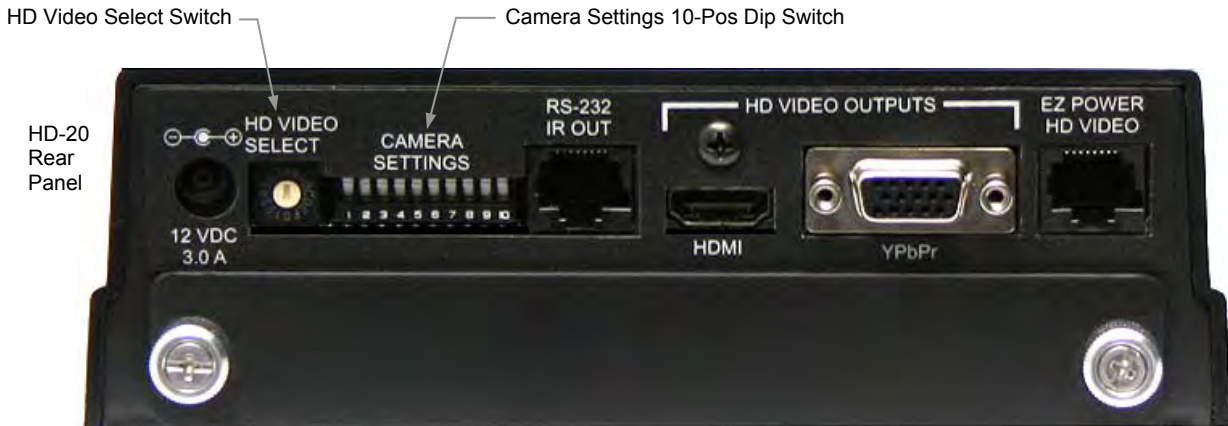

Label on the Bottom of the HD-20

DIP SWITCH SETTINGS										VIDEO SELECT			
IR 1 OFF	IR 2 OFF	IR 3 OFF	IR OUT OFF	9600 bps	IMAGE FLIP OFF	HDMI COLOR YCbCr	8 OFF	9 OFF	10 OFF	0	720p/59.94	8	---
<input checked="" type="checkbox"/>	<input checked="" type="checkbox"/>	<input checked="" type="checkbox"/>	<input checked="" type="checkbox"/>	<input checked="" type="checkbox"/>	<input checked="" type="checkbox"/>	<input checked="" type="checkbox"/>	<input checked="" type="checkbox"/>	<input checked="" type="checkbox"/>	<input checked="" type="checkbox"/>	1	1080i/59.94	9	---
<input checked="" type="checkbox"/>	<input checked="" type="checkbox"/>	<input checked="" type="checkbox"/>	<input checked="" type="checkbox"/>	<input checked="" type="checkbox"/>	<input checked="" type="checkbox"/>	<input checked="" type="checkbox"/>	<input checked="" type="checkbox"/>	<input checked="" type="checkbox"/>	<input checked="" type="checkbox"/>	2	1080p/30	A	---
<input checked="" type="checkbox"/>	<input checked="" type="checkbox"/>	<input checked="" type="checkbox"/>	<input checked="" type="checkbox"/>	<input checked="" type="checkbox"/>	<input checked="" type="checkbox"/>	<input checked="" type="checkbox"/>	<input checked="" type="checkbox"/>	<input checked="" type="checkbox"/>	<input checked="" type="checkbox"/>	3	720p/50	B	---
<input checked="" type="checkbox"/>	<input checked="" type="checkbox"/>	<input checked="" type="checkbox"/>	<input checked="" type="checkbox"/>	<input checked="" type="checkbox"/>	<input checked="" type="checkbox"/>	<input checked="" type="checkbox"/>	<input checked="" type="checkbox"/>	<input checked="" type="checkbox"/>	<input checked="" type="checkbox"/>	4	1080i/50	C	---
<input checked="" type="checkbox"/>	<input checked="" type="checkbox"/>	<input checked="" type="checkbox"/>	<input checked="" type="checkbox"/>	<input checked="" type="checkbox"/>	<input checked="" type="checkbox"/>	<input checked="" type="checkbox"/>	<input checked="" type="checkbox"/>	<input checked="" type="checkbox"/>	<input checked="" type="checkbox"/>	5	1080p/25	D	---
IR 1 ON	IR 2 ON	IR 3 ON	IR OUT ON	38400 bps	ON	sRGB	---	---	---	6	720p/60	E	---
<input type="checkbox"/>	<input type="checkbox"/>	<input type="checkbox"/>	<input type="checkbox"/>	<input type="checkbox"/>	<input type="checkbox"/>	<input type="checkbox"/>	<input type="checkbox"/>	<input type="checkbox"/>	<input type="checkbox"/>	7	1080i/60	F	---
1	2	3	4	5	6	7	8	9	10				

- Set the HD output resolution for the camera with the Rotary Switch.
- Set the IR frequency of the camera if it is to respond to the IR remote control.
- If using RS-232 for control, leave the IR OUT OFF (SW4) and choose 9600bps for most applications.
- If using the IR forwarding feature, turn the IR OUT ON (SW4).
- If inverting the camera, turn the IMAGE FLIP ON (SW6).

Dip Switches:

IR 1, 2 & 3: The IR remote has the capability of operating up to three different PTZ cameras from one remote. Use the selector buttons at the top of the IR remote to select the frequency.

IR Out 4: The IR output is sent out on the RS-232 RJ-45 jack on the back of the camera. Turning on the IR output will allow IR signals to be transmitted over the CAT-5 cable to the head end. When using RS-232 control or Vaddio CCU controllers (also via RS-232), turn the IR OUT to OFF.

Baud Rate 5: The options for baud rate are either 9600 bps or 38,400 bps.

Image Flip 6: To invert the HD-20, turn the IMAGE FLIP ON (switch down).

HDMI Color or sRGB Color space 7 out of the HDMI Connector: Default is YCbCr. Use sRGB color space with older DVI-D 1.0 monitors only. The YCbCr color space is best for HDMI digital video.

Note: The Cat-5e connection to the Quick-Connect DVI/HDMI Interface YCbCr only. Some older DVI-D 1.0 monitors may not display the image properly.

Switches 8, 9 and 10: Leave up - or in the OFF

System Connectivity Example 1:

Basic system connectivity of a Vaddio WallVIEW™ DVI/HDMI HD-20 and Quick-Connect DVI/HDMI SR Interface with Vaddio ProductionVIEW™ Precision Camera Controller and PreVIEW HD Monitors.

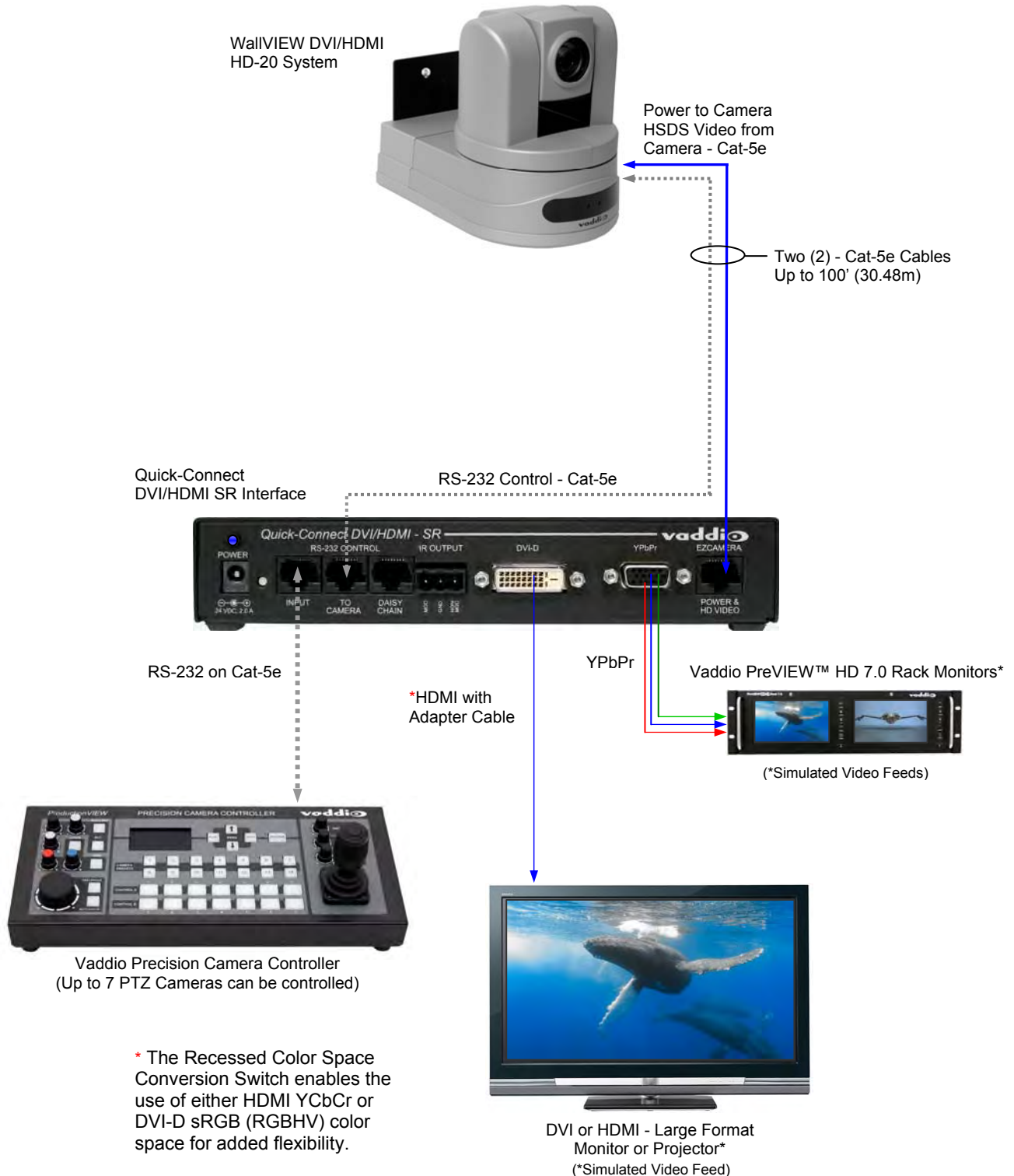

System Connectivity Example 2: System connectivity of two (2) Vaddio HD-20 cameras and two (2) Quick-Connect DVI/HDMI SR Interfaces configured with single control port codec and Daisy Chain Control Emulation (DCCE).

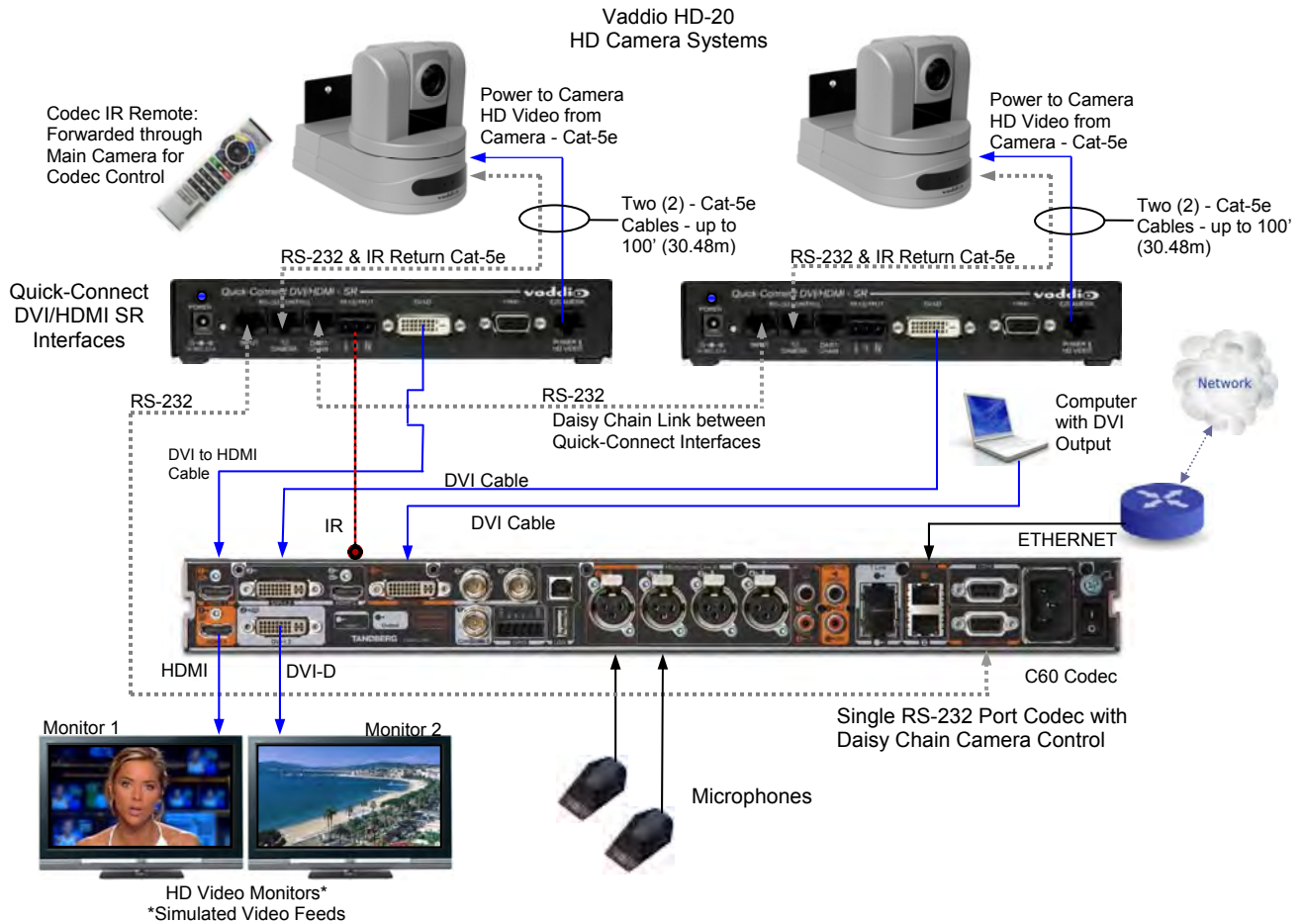

Mounting and Installation Instructions for the CONCEAL Wall Mounting System:

Step 1: Determine Camera Mount Location

When locating the camera, consider viewing angles, lighting conditions, possible line of site obstructions and check for in-wall obstructions where the camera is to be mounted. Pick a mounting location to optimize the performance of the camera. After determining the optimum location of the camera system, route the required two (2) Cat-5e cables from the camera to the head-end.

The two (2) Cat-5e cables should feed-through a 1" (25.4mm) opening (circular or square shape) centered in the rectangular slot located on the rear flange of the CONCEAL Wall Mount Bracket (see Fig. 1).



Note: Do not cut out the entire rectangular slot opening in the wall! This will not allow the two-lower wall anchors to correctly fasten the Conceal Wall Mount to the wall (see Fig. 1).

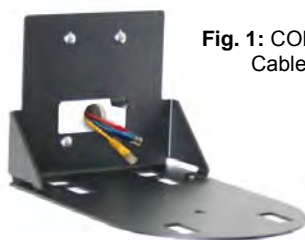

Fig. 1: CONCEAL Wall Mount Bracket: Cabled and Attached to Wall



Fig. 2: Vaddio HD-20 Camera aligned and attached to the CONCEAL Wall Mount Bracket

If the bracket is to be mounted on a 2-gang wall box, use the screws supplied with the wall box cover plate to attach the CONCEAL Wall Mount Bracket.

If mounting to drywall with wall anchors, use the four (4) quality wall anchors/screws provided (see Fig. 1). Note: The mounting holes are slotted and are 90° opposing to provide easy leveling. Level the mount and tighten the mounting screws.



Note: Check all Cat-5e cables for continuity in advance of final connection. Plugging the EZ POWER/VIDEO Cat-5e Cable into the wrong RJ-45 may cause damage to the camera system and void the warranty!

Step 2: System Wiring

Follow the sample wiring diagram on the previous pages for connecting the Cat-5e cables to the camera and Quick-Connect DVI/HDMI SR Interface. Additional diagrams are available on our website for installation with a variety of videoconferencing codecs.

Step 3: Secure the Camera To the CONCEAL Wall Mount Bracket:

After all cables are attached to the camera, place the camera onto the camera mount and insert the two-(1/4"-20) screws into the camera through the two-screw holes in the bottom of the mount.



Note: Be sure to align each side of the camera evenly to all sides of the CONCEAL Wall Mount Bracket before final tightening of the mounting screws (see Fig. 2).

Step 4: Install the CONCEAL Lower Cover Plate:

Attach lower CONCEAL Lower Cover Plate (see Fig. 3). Slide lower cover plate from front of the mounting bracket toward the rear of the bracket. The two-rear locking tabs will need to be guided into position first and will lock in place as the lower cover plate is pushed toward the rear of the mounting bracket and the front tabs are inserted (see Fig. 4).

Fig. 3: CONCEAL Lower Cover Plate with Locking Tabs



Fig. 4: CONCEAL Lower Cover Plate locked in place



Step 5: Install the CONCEAL Rear Camera Cover:

After successful testing of the camera, install the Conceal Rear Camera Cover on the CONCEAL Mounting Bracket with the supplied screw (see Figs. 5 and 6).

Fig. 5: CONCEAL Rear Camera Cover



Fig. 6: Completed CONCEAL Wall Mount Camera Bracket Installation



Step 6: At the head end, plug the Cat-5e cable labeled Power/Video into the EZCamera POWER & HD VIDEO RJ-45 jack on the Quick-Connect DVI/HDMI Interface. Plug the Cat-5e marked RS-232 into the RS-232 CONTROL - TO CAMERA RJ-45.

Step 7: Plug your RS-232 controller (Vaddio's ProductionVIEW HD, Precision Camera Controller, ControlVIEW XHD, AutoPresenter, etc...) into the RS-232 CONTROL INPUT. If you are using a 3rd party controller (Crestron®, or AMX®) use the provided 9-pin to RJ-45 control adapter and then a Cat-5e cable to plug this RS-232 controller into this port.

Step 8: Connect the HD Video Outputs (DVI or HDMI with adapter cable - or - analog HD YPbPr video) into a display device or video console. Please make sure that the video console or the display device is set up to receive the HD camera resolution that was chosen with the rotary switch on page 6. Most monitors are automatic, however all consoles will need set-up prior to termination.

Step 9: Connect the Vaddio 24 VDC, 2.0A power supply to the POWER Connector on the Quick-Connect and plug the power adapter into an AC outlet. Power will travel down the Power/Video Cat-5e cable to the camera. The camera will “Home” to a centered position, return HSDS video back to the Quick-Connect and is ready for control from the IR remote or RS-232 camera controller. **Boot Order: Always turn the cameras on first, then the controller or codec.**

Daisy Chain Configurations/Installation Instructions: In some cases, daisy chain control situations just can’t be avoided. Because of this, Vaddio added “Daisy Chain Control Emulation” or DCCE™ to the Quick-Connect DVI/HDMI - SR Interface in order to use the HD-20 camera in these situations. See Connectivity Example 2 (previous page) where the codec requires daisy chain control wiring.

- 1) For daisy chain control, first complete steps above, since all the cabling between the camera and the Quick-Connect DVI/HDMI Interface is the same.
- 2) Instead of running a cable from the 1st camera to the 2nd camera, run a Cat-5e patch cable from the 1st Quick-Connect DVI/HDMI Interface’s RS-232 CONTROL DAISY CHAIN RJ-45 jack, to the 2nd Quick-Connect DVI-HDMI SR Interface’s RS-232 CONTROL INPUT RJ-45 jack.
- 3) Within the modified VISCA® protocol that the codec and the HD-20 use, the 1st in the chain will set up as Camera #1, the second will set up as Camera #2 in the chain, allowing the codec IR remote to select which camera it will switch to and which to control.
- 4) In the case of TANDBERG codecs, use the IR Modulated output of the Quick-Connect and a Xantech IR emitter (282D or 283D) and attach the emitter to the front panel of the codec (in front of the IR receiver).
- 5) Polycom codecs with IR receivers can connect the IR feed-through the same way as the TANDBERG, but do not use daisy chain control. Several Polycom codecs can also be connected directly with the non-modulated signal to the codec’s IR signal input port.

Basic Daisy Chain Connectivity:

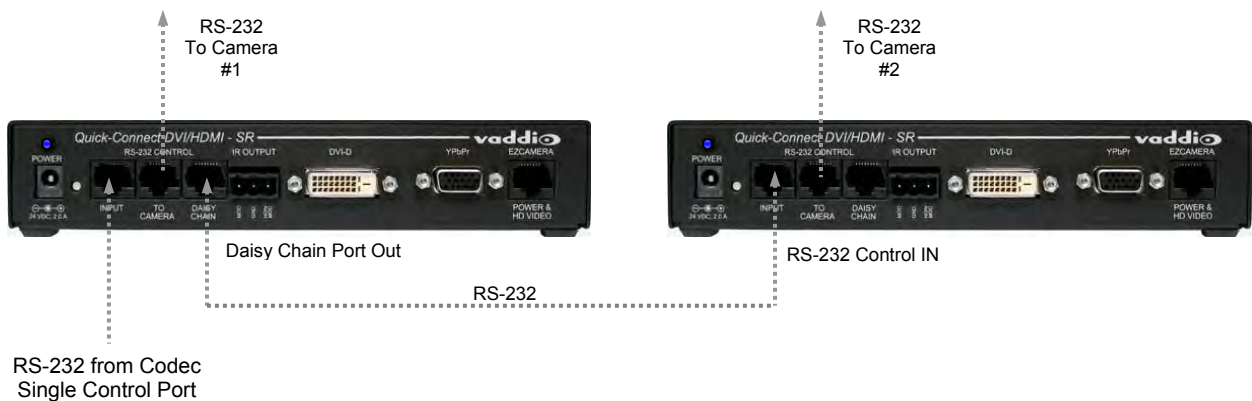

General Specifications:

WallVIEW DVI/HDMI HD-20	
Part Numbers	WallVIEW DVI/HDMI HD-20 999-6956-000 (North America) WallVIEW DVI/HDMI HD-20 999-6956-001 (International)
Vaddio ClearVIEW HD-20	
Image Device	6.49mm diagonal (1/2.8 Type) Exmor High-speed CMOS Image Sensor
Picture Elements	3.27M pixels (Effective)
HD Resolutions	1080i/59.94/60, 1080/50i, 720p/59.94/60, 720/50p, 1080/30p and 1080/25p (SD Resolutions not Supported)
Color Space:	The Recessed Color Space Conversion Switch enables the use of either HDMI YCbCr or DVI-D sRGB (RGBHV) color space for added flexibility with adapter cables.
Lens	20x Optical Zoom, 11-Element HiLD™ (High Index Low Dispersion) Glass
Focal Length	F=4.7mm wide end to 94mm tele end
Horizontal Viewing Angle (16:9 format)	1080i Mode: 2.9° tele end to 55.2° wide end 720p Mode: 1.93° tele end to 36.8° wide end (windowed - not scaled)
Invertible	Yes - With No Frame Delay
Video S/N Ratio	>50 dB
Minimum Illumination	1.6 LUX (F1.6, 50IRE)
Serial Control Protocol	RS-232 (Modified VISCA)
Min. Object Distance	Wide End: .01m wide end, Tele end: 1.0m
Pan Range	+170 degrees to -170 degrees
Tilt Range	+90 degrees to -30 degrees
HD Video Select	16-Position Rotary Switch: Used to set HD Video Resolution Output
Camera Settings	10-Position Dip Switch: Settings for IR Select, Baud Rate 9600, Image Flip, Unpublished Functions
Preset Positions	16 (internal), 6 recalled via IR Remote
Dimensions/Weight	7.81" (198.37mm) x 6.67" (169.42mm) x 7.057" (179.25. mm), 5.61 lbs. (2.54011744 kg.)
Quick-Connect DVI/HDMI SR (Short Range) Interface	
Connectors	<ul style="list-style-type: none"> • Power Connector: 5.5mm OD, 2.5mm ID coaxial connector • RJ-45: Four (4) Control IN, Control OUT, Daisy Chain OUT, EZCamera Power Video Port • Video Output: DE-15 connector for HD Analog Component (Y,PB,PR) video only (No SD Support) • IR Output: Transmits modulated or non-modulated IR signals received from the HD-20 IR receiver • Video Outputs: Video Outputs: DVI-D (Female - Single Link) or HDMI with adapter cable (using the Recessed Color Space Conversion Switch) , DE-15F (High Density D-Sub 15-Pin F) for HD YPbPr
Cat-5e Cable Distance	Up to 100' (30.5m)
Power Supply	24 VDC, 2 Amp
Dimensions / Weight	1.6" (40.64mm) H x 8" (203.2mm) W x 6.751" (171.45mm) D, ½-Rack Size / 1.21 lbs. (0.548846804 kg)
Accessory Options	1-RU Rack Mount Panel for two (2) units (side by side): P/N: 998-6000-003 1m (3.3') DVI-D Male to HDMI Male P/N: 440-5643-001 3m (10') DVI-D Male to HDMI Male P/N: 440-5643-003
CONCEAL Wall Mounting System for Vaddio ClearVIEW HD-20	
Dimensions	5.125" H x 6.75" W x 10" D (13 cm x 17.15 cm x 25.4 cm)
Weight	Approx. 2.4 lbs. (1.1kg)

Compliance and CE Declaration of Conformity - HD-20 PTZ Camera

Compliance testing was performed to the following regulations:

- | | |
|---|---------|
| • FCC Part 15, Subpart B | Class A |
| • ICES-003, Issue 4: 2004 | Class A |
| • European Standard EN 55022 A: 2006 + A1: 2007(CISPR 22:2005/A1:2005) | Class A |
| • AS/NZS CISPR 22: 2009 | Class A |
| • VCCI V-3/2010.04 | Class A |
| • Korean Requirements KN22: KCC Notice Number 2009-27 | Class A |
| • EMC Directive 2004/108/EC | Class A |



FCC Part 15 Compliance

This equipment has been tested and found to comply with the limits for a Class A digital device, pursuant to Part 15, Subpart B, of the FCC Rules. These limits are designed to provide reasonable protection against harmful interference when the equipment is operated in a commercial environment. This equipment generates, uses, and can radiate radio frequency energy and, if not installed and used in accordance with the instruction manual, may cause harmful interference to radio communications. Operation of this equipment in a residential area is likely to cause harmful interference in which case the user will be required to correct the interference at his/her own expense.

Operation is subject to the following two conditions: (1) This device may not cause interference, and (2) This device must accept any interference including interference that may cause undesired operation of the device.

Changes or modifications not expressly approved by Vaddio can affect emission compliance and could void the user's authority to operate this equipment.



ICES-003 Compliance

This digital apparatus does not exceed the Class A limits for radio noise emissions from digital apparatus set out in the Radio Interference Regulations of the Canadian Department of Communications.

Le présent appareil numérique n'émet pas de bruits radioélectriques dépassant les limites applicables aux appareils numériques de la classe A prescrites dans le Règlement sur le brouillage radioélectrique édicté par le ministère des Communications du Canada.



European Compliance

This product has been evaluated for Electromagnetic Compatibility under the EMC Directive for Emissions and Immunity and meets the requirements for a Class A digital device. In a domestic environment this product may cause radio interference in which case the user may be required to take adequate measures.

Standard(s) To Which Conformity Is Declared:

EMC Directive 2004/108/EC

EN 55024: 1998 + Amendments A1: 2001 + A2: 2003

- EN 61000-4-2: 1995 + Amendments A1: 1998 + A2: 2001
- EN 61000-4-3: 2006 + A1: 2008
- EN 61000-4-4: 2004 + Corrigendum 2006
- EN 61000-4-5: 2006
- EN 61000-4-6: 2009
- EN 61000-4-8: 2010
- EN 61000-4-11: Second Edition: 2004

Immunity

Electrostatic Discharge

Radiated Immunity

Electrical Fast Transients

Surge Immunity

Conducted Immunity

Power Frequency Magnetic Field

Voltage Dips, Interrupts and Fluctuations

Korean Requirements:

- EN 61000-4-2 with KCC Notice No. 2009-27
- EN 61000-4-3 with KCC Notice No. 2009-27
- EN 61000-4-4 with KCC Notice No. 2009-27
- EN 61000-4-5 with KCC Notice No. 2009-27
- EN 61000-4-6 with KCC Notice No. 2009-27
- EN 61000-4-8 with KCC Notice No. 2009-27
- EN 61000-4-11 with KCC Notice No. 2009-27

Compliance and CE Declaration of Conformity - Quick-Connect DVI/HDMI SR Interface

Compliance testing was performed to the following regulations:

- **FCC Part 15, Subpart B** Class A
- **ICES-003, Issue 4: 2004** Class A
- **European Standard EN 55022 A: 2006 + A1: 2007(CISPR 22:2005/A1:2005)** Class A
- **EMC Directive 2004/108/EC** Class A



FCC Part 15 Compliance

- This equipment has been tested and found to comply with the limits for a Class A digital device, pursuant to Part 15, Subpart B, of the FCC Rules. These limits are designed to provide reasonable protection against harmful interference when the equipment is operated in a commercial environment. This equipment generates, uses, and can radiate radio frequency energy and, if not installed and used in accordance with the instruction manual, may cause harmful interference to radio communications. Operation of this equipment in a residential area is likely to cause harmful interference in which case the user will be required to correct the interference at his/her own expense.
- Operation is subject to the following two conditions: (1) This device may not cause interference, and (2) This device must accept any interference including interference that may cause undesired operation of the device.
- Changes or modifications not expressly approved by Vaddio can affect emission compliance and could void the user's authority to operate this equipment.



ICES-003 Compliance

This digital apparatus does not exceed the Class A limits for radio noise emissions from digital apparatus set out in the Radio Interference Regulations of the Canadian Department of Communications.

Le présent appareil numérique n'émet pas de bruits radioélectriques dépassant les limites applicables aux appareils numériques de la classe A prescrites dans le Règlement sur le brouillage radioélectrique édicté par le ministère des Communications du Canada.



European Compliance

This product has been evaluated for Electromagnetic Compatibility under the EMC Directive for Emissions and Immunity and meets the requirements for a Class A digital device. In a domestic environment this product may cause radio interference in which case the user may be required to take adequate measures.

Ferrite cylinders are included in order to the Quick-Connect DVI/HDMI SR Interface to strictly comply with the European Community EMC Directives compliance. Use these ferrites to ensure the elimination of possible EMI interference from cell phones and AC motors.

Standard(s) To Which Conformity Is Declared:

EMC Directive 2004/108/EC

EN 55022 A: 2006 + A1 2007 (CISPR 22:2005/A1:2005) Conducted and Radiated Emissions

EN 55024: 1998 + Amendments A1: 2001 + A2: 2003 - Electromagnetic Compatibility - Immunity

EN 61000-4-2 Electrostatic Discharge

EN 61000-4-3 Radiated Immunity

EN 61000-4-4 Electrical Fast Transients

EN 61000-4-5 Surge Immunity

EN 61000-4-6 Conducted Immunity

EN 61000-4-8 Power Frequency Magnetic Field

EN 61000-4-11 Voltage Dips, Interrupts and Fluctuations

WARRANTY INFORMATION

(See Vaddio Warranty Policies posted on vaddio.com for complete details):

Hardware* Warranty: One year limited warranty on all parts. Vaddio warrants this product against defects in materials and workmanship for a period of one year from the day of purchase from Vaddio. If Vaddio receives notice of such defects during the warranty period, they will, at their option, repair or replace products that prove to be defective.

Exclusions: The above warranty shall not apply to defects resulting from: improper or inadequate maintenance by the customer, customer applied software or interfacing, unauthorized modifications or misuse, operation outside the normal environmental specifications for the product, use of the incorrect power supply, improper extension of the power supply cable or improper site operation and maintenance.

Vaddio Customer Service: Vaddio will test, repair, or replace the product or products without charge if the unit is under warranty and is found to be defective. If the product is out of warranty, Vaddio will test then repair the product or products. The cost of parts and labor charge will be estimated by a technician and confirmed by the customer prior to repair. All components must be returned for testing as a complete unit. Vaddio will not accept responsibility for shipment after it has left the premises.

Vaddio Technical Support: Vaddio technicians will determine and discuss with the customer the criteria for repair costs and/or replacement. Vaddio Technical Support can be contacted through one of the following resources: e-mail support at support@vaddio.com or online at www.vaddio.com.

Return Material Authorization (RMA) Number: Before returning a product for repair or replacement, request an RMA from Vaddio's technical support. Provide a technician with a return phone number, e-mail address, shipping address, and product serial numbers and describe the reason for repairs or returns as well as the date of purchase and proof of purchase. Include your assigned RMA number in all correspondence with Vaddio. Write your assigned RMA number on the outside of the box when returning the product. All returns are subject to a restocking fee without exception (see warranty policies at vaddio.com).

Voided Warranty: The warranty does not apply if the original serial number has been removed or if the product has been disassembled or damaged through misuse, accident, modifications, or unauthorized repair. Cutting the power supply cable on the secondary side (low voltage side) to extend the power to the device (camera or controller) voids the warranty for that device.

Shipping and Handling: Vaddio will not pay for inbound shipping transportation or insurance charges or accept any responsibility for laws and ordinances from inbound transit. Vaddio will pay for outbound shipping, transportation, and insurance charges for all items under warranty but will not assume responsibility for loss and/or damage by the outbound freight carrier. If the return shipment appears damaged, retain the original boxes and packing material for inspection by the carrier. Contact your carrier immediately.

Products Not Under Warranty: Payment arrangements are required before outbound shipment for all out of warranty products.

*Vaddio manufactures its hardware products from parts and components that are new or equivalent to new in accordance with industry standard practices.

Other General Information:

Care and Cleaning

Do not attempt to take this product apart at any time. There are no user-serviceable components inside.

- Do not spill liquids or liquid type substances onto the device.
- Keep this device away from food or liquid.
- For smears or smudges on the devices, wipe with a clean, soft cloth.
- Do not use any abrasive pads or caustic chemicals at any time on any Vaddio equipment.

Operating and Storage Conditions:

Do not store or operate the device under the following conditions:

- Temperatures above 40°C (104°F) or temperatures below 0°C (32°F)
- High humidity, condensing or wet environments
- In inclement weather
- Dusty environments
- In a swimming pool or coastal cave environments
- Dry environments with an excess of static discharge
- In outer space (typically)
- Under severe vibration

Appendix 1: YPbPr Video Pin-Out for the HD-20 Camera & Quick-Connect Analog YPbPr Output

Pin	YPbPr
1	Pr
2	Y
3	Pb
4	-
5	-
6	Pr GND
7	Y GND
8	Pb GND
9	-
10	-
11	-
12	-
13	-
14	-
15	-

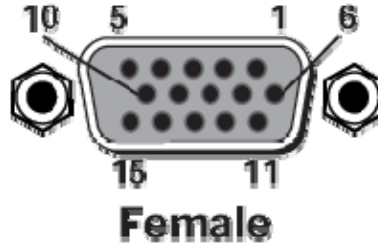

EZCamera Power & HD Video RJ-45 Connector Pin-outs

The video signals are differential (HSDS) and can only be transmitted by the HD-20 and received by the Quick-Connect SR Interface

Pin	YPbPr
1	Power+
2	Power-
3	Y+
4	PB+
5	PB GND
6	Y GND
7	PR+
8	PR-

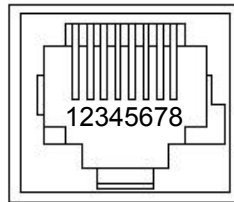

Appendix 2: ClearVIEW HD-20 Dimensions

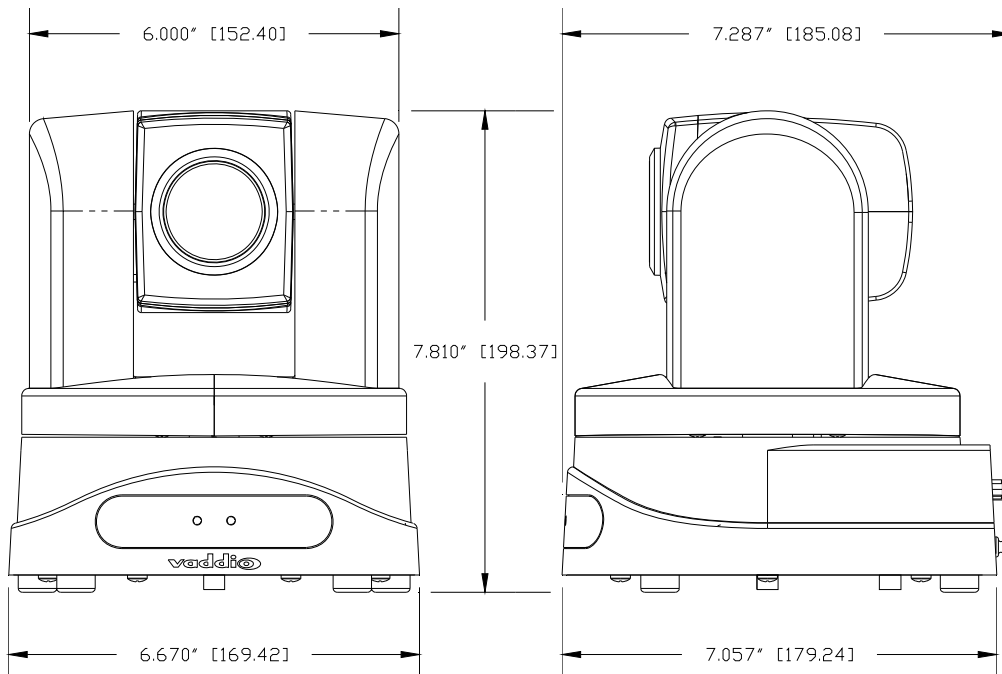

Appendix 3: Communication Specification

Communication Speed: 9600 bps (default)
 Start bit: 1
 Stop bit: 1
 Data bits: 8
 Parity: None
 No Flow control

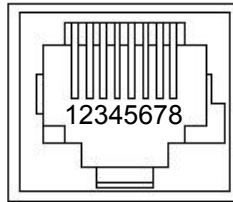

Pin #	RJ-45 RS-232 and IR Out Pins
1)	Unused
2)	Unused
3)	Unused
4)	IR Output (Diff Signal to Quick-Connect)
5)	IR Ground (Diff Signal to Quick-Connect)
6)	GND (GND of IR Short Range - Pin 3)
7)	RXD (from TXD of control source)
8)	TXD (to RXD of control source)

NOTE: The Vaddio ClearVIEW HD-20 Control Protocol is similar, but not identical to the Sony® VISCA™ command set in order to be compatible with several popular control devices. Not all VISCA commands are supported and there are many HD-20 specific commands in the following Command and Inquiry Lists.

HD-20 Command List (1/2)

Command Set	V	Command	Command Packet	Comments
AddressSet	Y	Broadcast	88 30 01 FF	Address Set
IF_Clear	Y	Broadcast	88 01 00 01 FF	I/F Clear
CommandCancel	Y		81 2p FF	p: Socket No(=1 to2)
CAM_Power	Y	On	81 01 04 00 02 FF	Power On/Off
	Y	Off	81 01 04 00 03 FF	
CAM_Zoom	Y	Stop	81 01 04 07 00 FF	p:0(Slow) to 7(Fast) p:0(Slow) to 7(Fast) pqrs:Zoom Pos 0x000-0x6400* V:(Speed) 0-7
	Y	Tele(Standard)	81 01 04 07 02 FF	
	Y	Wide(Standard)	81 01 04 07 03 FF	
	Y	Tele(Variable)	81 01 04 07 2p FF	
	Y	Wide(Variable)	81 01 04 07 3p FF	
	Y	Direct	81 01 04 47 0p 0q 0r 0s FF	
CAM_Focus	Y	Direct(Variable)	81 01 7E 01 4A 0V 0p 0q 0r 0s FF	Supported as 'Standard' Supported as 'Standard' pqrs:0x000-0xC00*
	Y	Stop	81 01 04 08 00 FF	
	Y	Far(Standard)	81 01 04 08 02 FF	
	Y	Near(Standard)	81 01 04 08 03 FF	
	Y	Far(Variable)	81 01 04 08 2p FF	
	Y	Near(Variable)	81 01 04 08 3p FF	
	Y	AutoFocus	81 01 04 38 02 FF	
	Y	ManualFocus	81 01 04 38 03 FF	
Y	Auto/Manual	81 01 04 38 10 FF		
Y	Direct	81 01 04 48 0p 0q 0r 0sFF		
CAM_WB	Y	Auto	81 01 04 35 00 FF	
	Y	Manual	81 01 04 35 05 FF	
CAM_RGain	Y	Reset	81 01 04 03 00 FF	prq:000-0x27f
	Y	Up	81 01 04 03 02 FF	
	Y	Down	81 01 04 03 03 FF	
	Y	Direct	81 01 04 43 00 0p 0q 0rFF	
CAM_BGain	Y	Reset	8x 01 04 04 00 FF	prq:000-0x27f
	Y	Up	8x 01 04 04 02 FF	
	Y	Down	81 01 04 04 03 FF	
	Y	Direct	81 01 04 44 00 0p 0q 0rFF	
CAM_AE	Y	Full Auto	81 01 04 39 00 FF	Auto Exposure Mode Manual Control Mode Shutter Priority Mode Exposure Priority Mode (default)
	Y	Manual	81 01 04 39 03 FF	
	Y	Shutter Priority	81 01 04 39 0A FF	
	Y	Iris Priority	81 01 04 39 0B FF	
CAM_Iris	Y	Reset	81 01 04 0B 00 FF	pq:0x0-0x0B
	Y	Up	81 01 04 0B 02 FF	
	Y	Down	81 01 04 0B 03 FF	
	Y	Direct	81 01 04 4B 00 00 0p 0q FF	
CAM_Gain	Y	Reset	81 01 04 0C 00 FF	pq:0x0-0x24
	Y	Up	81 01 04 0C 02 FF	
	Y	Down	81 01 04 0C 03 FF	
	Y	Direct	81 01 04 4C 00 00 0p 0q FF	

***Zoom and Focus Data:**

CAM_Zoom: Range(0x000–0x6400)

CAM_Focus: Range (0x000-0xC000) dependent on Zoom Position

HD-20 Command List (2/2)

Command Set	V	Command	Command Packet	Comments
CAM_Backlight	Y	On	81 01 04 33 02 FF	
	Y	Off	81 01 04 33 03 FF	
CAM_Aperture	Y	Reset	81 01 04 02 00 FF	
	Y	Up	81 01 04 02 02 FF	
	Y	Down	81 01 04 02 03 FF	
	Y	Direct	81 01 04 42 00 00 0p 0q FF	pq:0x0-0x35
CAM_Memory	Y	Reset	81 01 04 3F 00 0p FF	p:Memory No(=0-0xf)
	Y	Set	81 01 04 3F 01 0p FF	
	Y	Recall	81 01 04 3F 02 0p FF	
CAM_IDWrite	Y		81 01 04 22 0p 0q 0r 0s FF	pqrs:Camera ID(==0000 – FFFF)
IR_Receive	Y	On	81 01 06 08 02 FF	
	Y	Off	81 01 06 08 03 FF	
	Y	On/Off	81 01 06 08 10 FF	
IR_ReceiveReturn	N+	On	81 01 7D 01 03 00 00 FF	
	N+	Off	81 01 7D 01 13 00 00 FF	
Pan-tiltDrive	Y	Up	81 01 06 01 VV WW 03 01 FF	WW: Pan Speed (0x01-0x18) VV:Tilt Speed(0x01-0x14)
	Y	Down	81 01 06 01 VV WW 03 02 FF	
	Y	Left	81 01 06 01 VV WW 01 03 FF	
	Y	Right	81 01 06 01 VV WW 02 03 FF	
	Y	UpLeft	81 01 06 01 VV WW 01 01 FF	
	Y	UpRight	81 01 06 01 VV WW 02 01 FF	
	Y	DownLeft	81 01 06 01 VV WW 01 02 FF	
	Y	DownRight	81 01 06 01 VV WW 02 02 FF	
	Y	Stop	81 01 06 01 VV WW 03 03 FF	
	Y	Absolute Position	81 01 06 02 VV WW 0Y 0Y 0Y 0Y 0Z 0Z 0Z 0Z FF 0Y 0Y 0Y 0Y 0Z 0Z 0Z 0Z FF	YYYY: Pan Position** ZZZZ: Tilt Position**
	Y	Home	81 01 06 04 FF	
Y	Reset	81 01 06 05 FF		
Tally	Y	On	81 01 7E 01 0A 00 02 FF	
	Y	Off	81 01 7E 01 0A 00 03 FF	
Preset Pan Speed	Y	Pan/Tilt Speed	81 01 7E 01 0B WW VV ZZ FF	WW: Pan Speed (0x01-0x18) VV:Tilt Speed(0x01-0x14) ZZ:Zoom Speed(0-7);
Motor Config	Y	Hard Motor Stops	81 01 7E 01 70 00 00 FF	
	Y	Soft Motor Stops	81 01 7E 01 70 00 01 FF	
BLK.Enhance	Y	Pedestal	81 01 7E 53 00 00 0p 0q FF	Black Level (pq:0x0-0x5F)
GMA.Enhance	Y	Gamma	81 01 7E 54 00 00 0p 0q FF	pq:0x0-0xCF
CRM.Enhance	Y	Chroma	81 01 7E 55 00 00 0p 0q FF	pq:0x0-0xAF
KNE.Enhance	Y	Knee	81 01 7E 56 00 00 0p 0q FF	pq:0x0-0xFF
CAM_Shutter	Y	Reset	81 01 04 0A 00 FF	(Only supported in Shutter Priority Mode)
	Y	Up	81 01 04 0A 02 FF	
	Y	Down	81 01 04 0A 03 FF	
	Y	Direct	81 01 04 42 00 00 0p 0q FF	pq:0x0-0x0F
CAM_ExpComp	Y	On	81 01 04 3E 02 FF	AutoExposure Off
	Y	Off	81 01 04 3E 03 FF	
	Y	Reset	81 01 04 0E 00 FF	AutoExposure On
	Y	Up	81 01 04 0E02 FF	
	Y	Down	81 01 04 0E 03 FF	
	Y	Direct	81 01 04 4C 00 00 0p 0q FF	
CAM_ICR Cut Filter	Y	ICR On	81 01 04 01 02 FF	ICR On
	Y	ICR Off	81 01 04 01 03 FF	ICR Off

**** Additional Information:**

Pan Range: 8044 – 7FBC (-32,700 to +32,700)

Tilt Range: E891 – 4C2B (-5,999 to +19,499)

Actual Pan/Tilt ranges defined in Inquiry list

HD-20 Inquiry List (1/1)

Inquiry Command	V	Command	Command Packet	Comments
CAM_PowerInq	Y	81 09 04 00 FF	y0 50 02 FF y0 50 03 FF	On Off(Standby)
CAM_ZoomPosInq	Y	81 09 04 47 FF	y0 50 0p 0q 0r 0s FF	pqr: Zoom Position
CAM_WBModelInq	Y	81 09 04 35 FF	y0 50 00 FF y0 50 05 FF	Auto Manual
CAM_RGain	Y	81 09 04 43 FF	y0 50 00 0p 0q 0r FF	pqr:000-1ff
CAM_BGain	Y	81 09 04 44 FF	y0 50 00 0p 0q 0r FF	pqr:000-1ff
CAM_AEModeInq	Y	81 09 04 39 FF	y0 50 00 FF y0 50 03 FF	Auto Exposure Mode Manual Control Mode
CAM_Iris	Y	81 09 04 4B FF	y0 50 00 00 0p 0q FF	pp(0x00-0x11)
CAM_Gain	Y	81 09 04 4C FF	y0 50 00 00 0p 0q FF	pp(0x00-0x1E)
CAM_BacklightModelInq	Y	81 09 04 33 FF	y0 50 02 FF y0 50 03 FF	On Off
CAM_FocusPosInq	Y	81 09 04 48 FF	Y0 50 0p 0q 0r 0s FF	Pqrs:Focus Pos 0x000-0x0C000
CAM_ApertureInq	Y	81 09 04 42 FF	y0 50 00 00 0p 0q FF	pp(0x00-0x3F)
CAM_MemoryInq	Y	81 09 04 3F FF	y0 50 0p FF	p:Memory No(=0-0xf)
CAM_IDInq	Y	81 09 04 3F FF	y0 50 0p 0q 0r 0s FF	pqrs:(0000 – FFFF)
CAM_ReceiveInq	Y	81 09 06 08 FF	y0 50 02 FF y0 50 03 FF	On Off
Pan-TiltMaxSpeedInq	Y	81 09 06 11 FF	y0 50 WW VV FF	WW: Pan Speed (0x01-0x18) VV:Tilt Speed(0x01-0x14)
Pan-tiltPositionInq	Y	81 09 06 12 FF	y0 50 0Y 0Y 0Y 0Y 0Z 0Z 0Z 0Z FF	YYYY: Pan (0x0100-0x1800) ZZZZ:Tilt (0x0100-0x1400)
TallyInq	Y Y	81 09 7E 01 0A FF	y0 50 02 FF y0 50 03 FF	On Off
PresetSpeedInq	Y	81 09 7E 01 0B FF	y0 50 WW VV ZZ FF	WW: Pan Speed (0x01-0x18) VV:Tilt Speed(0x01-0x14) ZZ:Zoom Speed(0-7);
Motor Config	Y	81 09 7E 01 70 FF	y0 50 00 FF y0 50 01 FF	Hard Motor Stops Soft Motor Stops
BLK.Enhance	Y	81 01 7E 53 FF	y0 50 00 00 0p 0q FF	pp: Black Level (0x01-0xFD)
GMA.Enhance	Y	81 01 7E 54 FF	y0 50 00 00 0p 0q FF	pp: Gamma (0x00-0x8F)
CRM.Enhance	Y	81 01 7E 55 FF	y0 50 00 00 0p 0q FF	pp: Chroma (0x08-0x1F)
KNE.Enhance	Y	81 01 7E 56 FF	y0 50 00 00 0p 0q FF	pp: Knee (0x0-07F)
CAM_AEModeInq	Y	81 09 04 39 FF	y0 50 00 FF y0 50 03 FF y0 50 0A FF y0 50 0B FF y0 50 0D FF	Auto Exposure Mode Manual Control Mode Shutter Priority Mode Exposure Priority Mode AGC Priority Mode
CAM_ShutterPosInq	Y	81 09 04 4A FF	y0 50 00 00 0p 0q FF	pp: ShutterPosition (Only supported in Shutter Priority Mode)
CAM_ExpCompModelInq	Y	81 09 04 3E FF	y0 50 02 FF y0 50 03 FF	On - AE Mode Off Off – AE Mode On
CAM_ExpCompPosInq	Y	81 09 04 4E FF	y0 50 00 00 0p 0q FF	pp: ExpComp Pos -Iris Position
CAM_ICRModelInq	Y	81 09 04 01 FF	y0 50 02 FF y0 50 03 FF	ICR On ICR Off



9433 Science Center Drive, Minneapolis, MN 55428
Toll Free: 800-572-2011 ▪ Phone: 763-971-4400 ▪ FAX: 763-971-4464
www.vaddio.com