

VADDIO/CANON[®] BU-SERIES PTZ CAMERAS

Canon BU-47H Outdoor & BU-51H Indoor PTZ Cameras with Vaddio Accessories for Easy Integration using the ProductionVIEW HD-SDI Console & Precision Camera Controller.

Part Numbers:

999-4147-000 Canon BU-47H Outdoor PTZ Camera System - North America (NTSC)

999-4147-001 Canon BU-47H Outdoor PTZ Camera System - International (PAL)

999-4151-000 Canon BU-51H Indoor PTZ Camera System - North America (NTSC)

999-4151-001 Canon BU-51H Indoor PTZ Camera System - International (PAL)

OVERVIEW

The Canon BU Series PTZ cameras (see Figure 1) are broadcast quality PTZ cameras, built around Canon camcorder technology. The BU-51H uses three 1/3", 1.67 Megapixel CCDs and a 20x optical zoom lens, while the BU-47H utilizes three 1/3", 2.37 Megapixel CCD's and an 18x optical zoom lens. The BU series cameras are ideal for virtually any indoor or outdoor application. The BU Series cameras are easily integrated with the Vaddio ProductionVIEW HD-SDI and Precision Camera Controller, with the included Vaddio cables and adapters. In addition, the native RS-422 found on the BU-47H is converted to RS-232 for operation with both ProductionVIEW HD-SDI and Precision Camera Controller. Optional accessories include both a wall mount and a pedestal mount for the indoor BU-51H.



Figure 1: Canon BU-46H Outdoor PTZ camera (upper left) and Canon BU-51H Indoor PTZ Camera (lower right).

INTENDED USE

Before installing the Canon BU Series Camera System, please read the manuals thoroughly. The BU-47H is designed for outdoor use and the BU-51H camera system is designed for use indoors. Outdoor operation of the BU-51H is not recommended, has not been tested, and could damage the camera and/or create a potentially unsafe operating condition. Use only the Vaddio PowerRite power supply provided with the BU-47H.

SAVE THESE INSTRUCTIONS

The information contained in this manual will help you install the Canon BU Series cameras. For reference, Vaddio keeps copies of Specifications, Installation and User Guides and most pertinent product drawings for the Vaddio product line on the website. These documents can be downloaded from vaddio.com

IMPORTANT SAFEGUARDS

Read and understand all instructions before using. Do not operate any electrical device if it has been dropped or damaged. In this case, a Vaddio technician must examine the product before operating. To reduce the risk of electric shock, do not immerse in water or other liquids and avoid extremely humid conditions.



Use only the power supply provided with the system. Use of any unauthorized power supply will void any and all warranties.



Please do not use "pass-thru" type RJ-45 connectors. These pass-thru type connectors do not work well for professional installations and can be the cause of intermittent connections which can result in the RS-232 control line failing and locking up, and/or compromising the SHSDS™ differential video. For best results please use standard RJ-45 connectors and test all cables for proper pin-out prior to termination.

INFORMATION

For RS-422 (BU-47H) and RS-232 (BU-51H) control information, please see the full-length Technical Manual for the specific camera. These manuals can be found either on the Vaddio or Canon websites. Vaddio has also

prepared a number of Tech Notes, specifications and drawings designed to inform and educate integrators on the value and the specific uses of Vaddio products.

UNPACKING

BU-47H System:

Carefully remove all of the parts from the packaging. Unpack and identify the following parts:

- One (1) Canon BU-47H PTZ Camera
- One (1) 12V PowerRite™ Power Supply with AC Cord Set (US or Euro and UK)
- One (1) RS-232 to RS-422 Converter (998-1000-422)
- One (1) RJ-45F to DB-9 Adapter (998-1005-232)
- One (1) RJ-45F to DB-9 Adapter (998-1003-232)
- One (1) RJ-45F to 12-pin Adapter
- One (1) 3' Cat. 5e Patch Cable (341-192)
- One (1) Vaddio Manual
- One (1) Canon BU-47H Manual

Figure 2: BU-47H Connected to Vaddio ProductionVIEW Precision Camera Controller

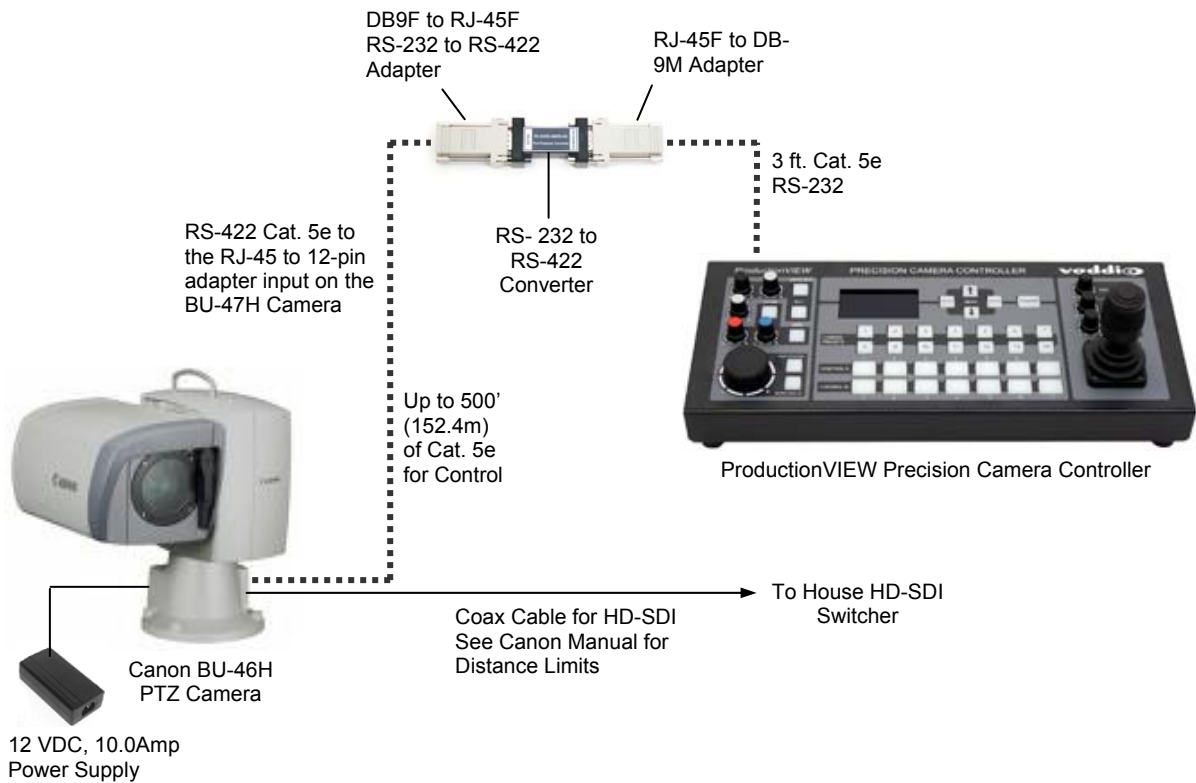

Basic Connectivity of the BU-47H Outdoor PTZ System:

The Vaddio/Canon BU-47H PTZ system uses a Cat. 5e for RS-232/RS-422 control to the camera. The RS-232 to RS-422 is port powered and it is recommended to be located close to the control source. While the Cat. 5e cable can be run up to 500' (152.4m) from the camera, the Canon BU-47H is rated for a distance up to 246' (75m). See Appendix 1 for wiring and pin-out information.

BU-51H System

Carefully remove all of the parts from the packaging. Unpack and identify the following parts:

- One (1) Canon BU-51H PTZ Camera
- One (1) RJ-45F to DB-9 Adapter (998-1007-232)
- One (1) AC Cord Set (US or Euro and UK)
- Vaddio Manual
- Canon BU-51H Manual

Figure 3:
BU-51H Connected to Vaddio ProductionVIEW HD-SDI Console

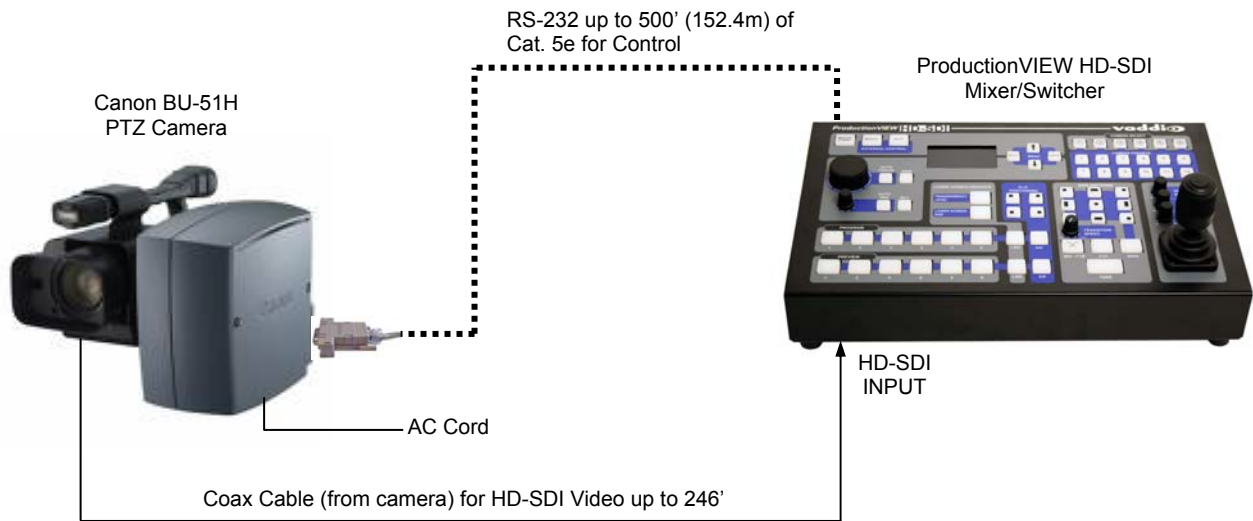

Basic Connectivity of the BU-51H Indoor PTZ System:

The Vaddio/Canon BU-51H PTZ system uses a Cat. 5e for RS-232 control to the camera. While the control Cat. 5e cable can be run up to 500' (152.4m) from the camera, the Canon BU-51H is rated for a distance up to 246' (75m). See Appendix 1 for wiring and pin-out information.

Optional Accessories:

NOTE: The mounts below are intended for indoor use only, using the BU-51H PTZ camera.



BU-Series CCU
999-4190-000 (NTSC)
999-4190-001 (PAL)



BU-51H Wall Mount
998-4150-001



BU-51H Pedestal Mount
998-4150-002

INSTALLATION

The instructions below are for wiring and configuring the Canon BU series cameras for installation with Vaddio joystick controllers. Please refer to the instruction manuals for the BU series cameras for assembling and configuring the cameras. The Canon BU series cameras are specifically designed for installation on a horizontal surface with Cat. 5 cable connectivity for RS-232/422 signaling, and coax cabling for video (HD-SDI and composite) and sync signals.

Before Installing

- Open the box for the camera system, and follow instructions related to camera set-up and configuration. For the BU-51H, this will include assembling the camera system to the pan/tilt head, as well as connecting power and control cables between the camera and pan/tilt system that are provided by Canon.
- Locate the camera mounting location paying close attention to camera viewing angles, lighting conditions, possible line of site obstructions, and checking for in-wall obstructions where the camera is to be mounted. Pick a mounting location to optimize the performance of the camera.
- An electrical outlet must be located near the Canon BU series PTZ cameras.
- Pre-wire all cabling as required (see wiring diagram examples).
- For the BU-47H Outdoor PTZ camera, the placement of the camera and any mount fabricated should take into consideration the environment that it will be placed in (temperature, wind loads, etc.) to assess whether these conditions conform to the specifications of the BU-47H. The power supply provided with the outdoor camera must be installed in a weatherproof housing.

MOUNTING INSTRUCTIONS

Step 1 (for BU-51H, go from Step 1 to Step 4 on page 6):

After determining the optimum location of the camera system, route the Cat. 5e and Coax cables from the camera to the Vaddio joystick controller. AC power is required for the BU-51H to operate, so a power outlet needs to be adjacent to the camera location. While the BU-47H operates on 12 volts DC, the power supply provided with the camera has terminal leads on it. The maximum distance the power supply can be located from the camera is 70 feet using 12 gauge wire, or 40 feet using 14 gauge wire. The power supply for the BU-47H must be installed in a weatherproof housing or location.

NOTE: Vaddio's joystick camera controllers transmit and receive data using RS-232. The BU-51H Indoor PTZ camera utilizes RS-232; however the BU-47H uses RS-422. A protocol converter, included with the Vaddio/Canon BU-47H system, is required for changing RS-232 to RS-422 in order for the BU-47H to operate. There will be some additional steps to follow for installation of the BU-47H camera system.

Step 2: BU-47H Camera System ONLY

Locate both the RJ-45 to DB-9M Adapters and the RS-232 to RS-422 converter. Screw the adapters into each side of the RS-232 to RS-422 Converter.

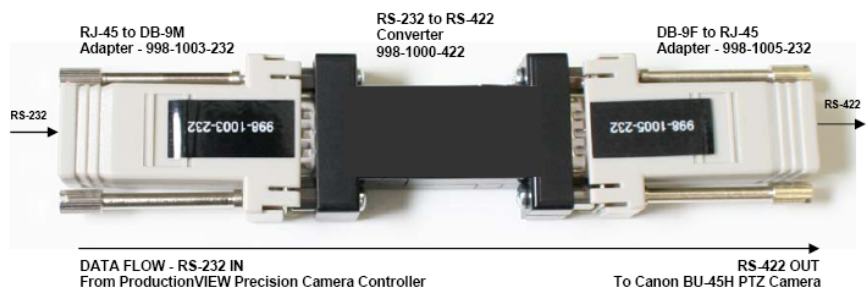

Step 3: BU-47H Camera System ONLY

Locate the 3 foot Cat. 5e patch cable and connect the RJ-45 to the Control port on the back of the Vaddio joystick controller. Connect the other end of the Cat. 5e cable to the RS-232 side of the RS-232 to RS-422 converter as shown.



Step 4: BU-47H Camera System ONLY

Carefully loosen the four hex screws from the housing on the back of the pan/tilt base. 18 inches of flexible plastic conduit is supplied with the camera, along with a coupler connected to the weatherproof housing on the back of the camera. The opening in the back of the housing is 1.67 inches in diameter if it is determined that another type of weatherproof conduit is required for the specific installation.

Connect the positive (+) and negative (-) connections to the screw terminals on the camera. Connect the BNC cable for HD-SDI to the SDI output connector. If sync and/or composite video is required for the installation run additional coax cables to the Sync and VBS ports on the back of the camera.

Next, remove the 12-pin connector that was supplied with the BU-47H by grasping the collar and pulling outward. Locate the 12-pin to RJ-45 adapter cable (see the diagram below), and connect the 12-pin connector to the camera. Plug in the Cat. 5e cable that was run to the camera and connect the RJ-45 connector to the other end of the 12-pin cable. Note: the RS-232 to RS-422 converter should be placed by the Vaddio joystick controller (see Figure 2).

NOTE: Be sure to turn on the power switch (labeled "POWER SW" in the diagram below) on the pan/tilt head, before putting the housing back on the pan/tilt base.

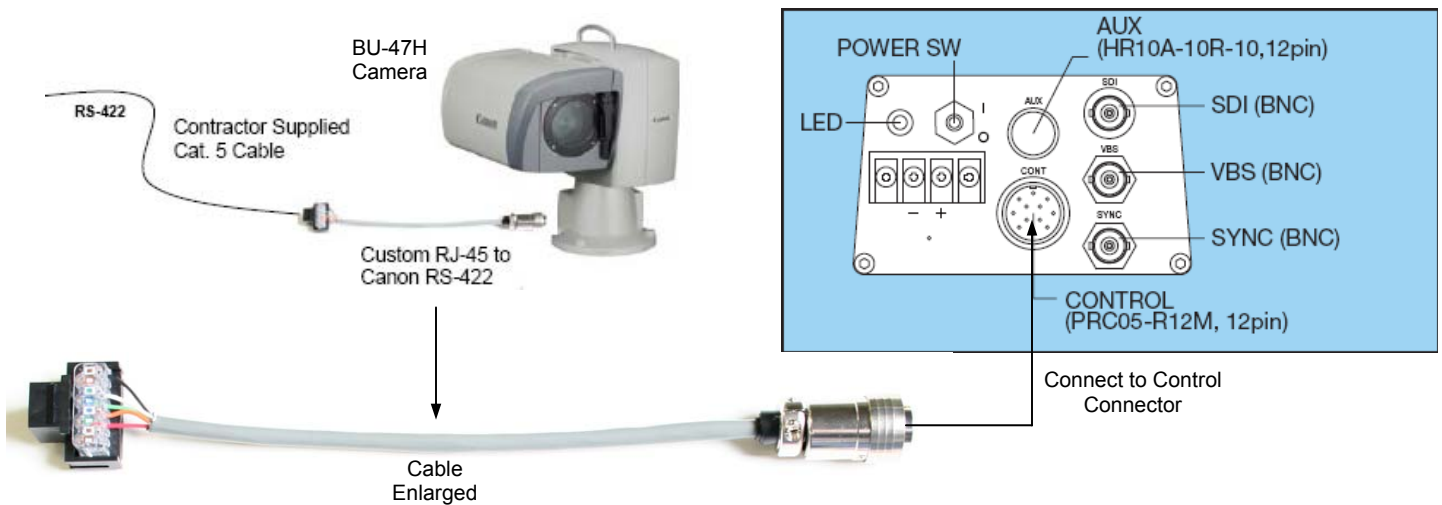

Step 4: BU-51H

Connect the RJ-45 to DB-9 adapter to the CONTROL port on the back of the pan/tilt head. Connect the power and control cables that were supplied with the BU-51H camera into the appropriate ports on the camera and pan/tilt head. Refer to the Canon manual for additional details on cable placement. Connect the AC cord to the back of the pan/tilt head.

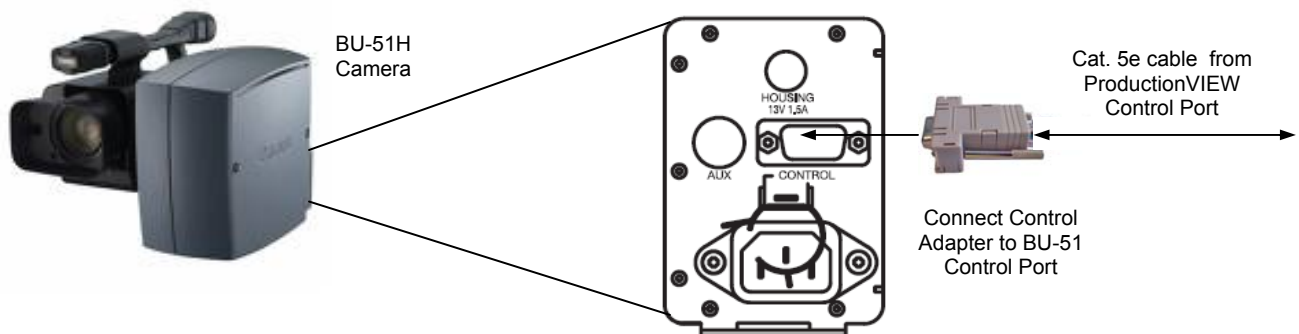

Step 5:

After completing the installation of the camera, connect the Cat. 5e cabling to the back of the Vaddio joystick controller. Follow the programming instructions provided with the Vaddio joystick controller in order for it to recognize the Canon BU series camera.

GENERAL SPECIFICATIONS

See individual product manuals for all specifications

Vaddio/Canon System Part Numbers

- 999-4147-000 Canon BU-47H Outdoor PTZ Camera System - North America (NTSC)
- 999-4147-001 Canon BU-47H Outdoor PTZ Camera System - International (PAL)
- 999-4151-000 Canon BU-51H Indoor PTZ Camera System - North America (NTSC)
- 999-4151-001 Canon BU-51H Indoor PTZ Camera System - International (PAL)

Appendix 1: Cable Pin-outs for the BU Series PTZ Cameras

- Pin-outs for the BU-47H Pan/Tilt RS-422 Adapter Cable:

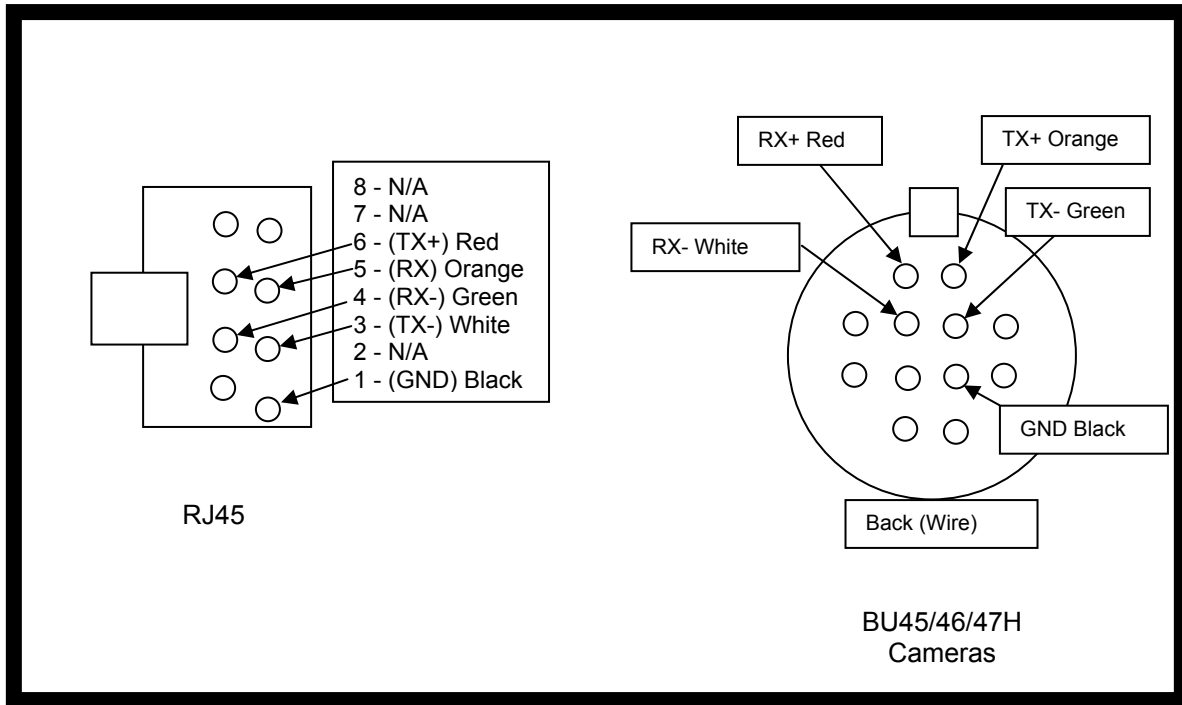

- Pin-out for the BU-51H Pan/Tilt RS-232 DB-9 Connector:

Pin number	Input/Output	Signal
2	Input	RX
3	Output	TX
5		GND

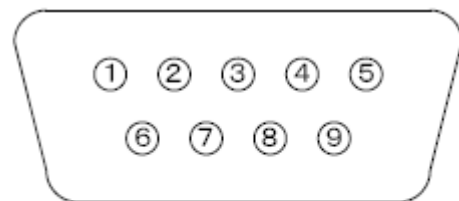

RS-232C pin assignment

Please See the Canon BU-47H and BU-51H Owners Manual for all other pin-out information.



WARRANTY INFORMATION (See Vaddio Warranty Policies posted on vaddio.com for complete details):

Hardware* Warranty - One year limited warranty on all parts. Vaddio warrants this product against defects in materials and workmanship for a period of one year from the day of purchase from Vaddio. If Vaddio receives notice of such defects during the warranty period, they will, at their option, repair or replace products that prove to be defective.

Exclusions - The above warranty shall not apply to defects resulting from: improper or inadequate maintenance by the customer, customer applied software or interfacing, unauthorized modifications or misuse, operation outside the normal environmental specifications for the product, use of the incorrect power supply, improper extension of the power supply cable or improper site operation and maintenance.

Vaddio Customer Service – Vaddio will test, repair, or replace the product or products without charge if the unit is under warranty and is found to be defective. If the product is out of warranty, Vaddio will test then repair the product or products. The cost of parts and labor charge will be estimated by a technician and confirmed by the customer prior to repair. All components must be returned for testing as a complete unit. Vaddio will not accept responsibility for shipment after it has left the premises.

Vaddio Technical Support - Vaddio technicians will determine and discuss with the customer the criteria for repair costs and/or replacement. Vaddio Technical Support can be contacted through one of the following resources: e-mail support at support@vaddio.com or online at www.vaddio.com.

Return Material Authorization (RMA) Number - Before returning a product for repair or replacement, request an RMA from Vaddio's technical support. Provide a technician with a return phone number, e-mail address, shipping address, and product serial numbers and describe the reason for repairs or returns as well as the date of purchase and proof of purchase. Include your assigned RMA number in all correspondence with Vaddio. Write your assigned RMA number on the outside of the box when returning the product. All returns are subject to a restocking fee (see warranty policies at vaddio.com).

Voided Warranty – The warranty does not apply if the original serial number has been removed or if the product has been disassembled or damaged through misuse, accident, modifications, or unauthorized repair. Cutting the power supply cable on the secondary side (low voltage side) to extend the power to the device (camera or controller) voids the warranty for that device.

Shipping and Handling - Vaddio will not pay for inbound shipping transportation or insurance charges or accept any responsibility for laws and ordinances from inbound transit. Vaddio will pay for outbound shipping, transportation, and insurance charges for all items under warranty but will not assume responsibility for loss and/or damage by the outbound freight carrier. If the return shipment appears damaged, retain the original boxes and packing material for inspection by the carrier. Contact your carrier immediately.

Products Not Under Warranty - Payment arrangements are required before outbound shipment for all out of warranty products.

*Vaddio manufactures its hardware products from parts and components that are new or equivalent to new in accordance with industry standard practices.

Other General Information:

Care and Cleaning

Do not attempt to take this product apart at any time. There are no user-serviceable components inside.

- Do not spill liquids or liquid type substances onto the device.
- Keep this device away from food or liquid.
- For smears or smudges on the devices, wipe with a clean, soft cloth.
- Do not use any abrasive pads or caustic chemicals at any time on any Vaddio equipment.

Operating and Storage Conditions:

Do not store or operate the device under the following conditions:

- Temperatures above 40°C (104°F) or temperatures below 0°C (32°F)
- High humidity, condensing or wet environments
- In inclement weather
- Dusty environments
- In a swimming pool or coastal cave environment
- Dry environments with an excess of static discharge
- In outer space
- Under severe vibration



131 Cheshire Lane, Suite 500, Minnetonka, MN. 55305
Toll Free: 800-572-2011 ▪ Phone: 763-971-4400 ▪ FAX: 763-971-4464
www.vaddio.com