

WALLVIEW™ PRO Z330 WITH HSDS™

Vaddio™ PRO Series Cable System for the Sony® BRC-Z330 High Definition PTZ Camera

OVERVIEW

The Vaddio WallVIEW PRO Z330 (Figure 1) is built around the Sony BRC-Z330 high definition PTZ Camera with a 1/3-type, 2 megapixel CMOS image sensor. The WallVIEW PRO Z330 uses high speed differential signaling (HSDS), an active transmission system to deliver superior video quality over Cat. 5 cabling distances up to 500 feet.

The WallVIEW PRO Z330 system is capable of 1080i or 720p HD video. Simultaneous SD video out (crop, squeeze or letterbox) is available simultaneously but requires an additional Cat. 5 cable and two Vaddio Quick-Connect boxes.

The WallVIEW PRO system also has many new features, including a unique IR forwarding system which allows the user to forward IR commands from third party IR remote controls, through the WallVIEW system to a third party device. Like all Vaddio WallVIEW systems, the Wall Mount and mounting hardware is included.



Figure 1:
WallVIEW PRO Z330 System with Camera,
Wall Mount and EZIM (behind camera)

INTENDED USE

Before installing the Vaddio WallVIEW PRO Z330 Camera System, please read the entire manual thoroughly. All Vaddio camera systems were designed for use indoors. Outdoor operation is not recommended, has not been tested, and could damage the camera and/or create a potentially unsafe operating condition. Use only the Vaddio PowerRite power supply provided.

SAVE THESE INSTRUCTIONS

The information contained in this manual will help you install the Vaddio WallVIEW PRO systems. For reference, Vaddio keeps copies of Specifications, Installation and User Guides and most pertinent product drawings for the Vaddio product line on the website. These documents can be downloaded from www.vaddio.com free of charge.

IMPORTANT SAFEGUARDS

Read and understand all instructions before using. Do not operate any electrical device if it has been dropped or damaged. In this case, a Vaddio technician must examine the product before operating. To reduce the risk of electric shock, do not immerse in water or other liquids and avoid extremely humid conditions.



Use only the power supply provided with the WallVIEW PRO Z330 system. Use of any unauthorized power supply will void any and all warranties.



Do not use "pass-thru" RJ-45 connectors. Use standard RJ-45 connectors for best results.

INFORMATION

For RS-232 control information, please see the full-length Technical Manual for the SONY BRC-Z330 model. This manual can be found either on the Vaddio or Sony website. Vaddio has also prepared a number of TechNotes, specifications and drawings designed to inform and educate integrators on the value and the specific uses of Vaddio products.

UNPACKING

Carefully remove all of the parts from the packaging. Unpack and identify the following parts:

- One (1) - Sony BRC-Z330 High Definition PTZ Camera and IR Remote Control
- One (1) - Vaddio EZ Interface Module (EZIM)
- One (1) - Vaddio EZIM to HD camera break out cable
- One (1) - Vaddio Quick-Connect PRO with HSDS (1-RU Rack Mountable)
- One (1) - Vaddio Thin Profile Z330 Wall Mount
- One (1) - EZCamera Control Adapter (RJ-45 to DB-9)
- One (1) - 36V PowerRite™ HD Power Supply with AC Cord Set
- One (1) - 2-position Phoenix Connector for IR
- Mounting Hardware
- Documentation
 - Vaddio Manual
 - Sony BRC-Z330 Manual

Optional Accessory: Quick-Connect Boxes for SD video (300 ft. limit) Part # - 998-1105-001 (2 required)

INSTALLATION

All WallVIEW products are specifically designed for installation on a vertical wall surface with Cat. 5 cable connectivity for Power, Video and Control signaling (three cables are required). Installation is simplified in that no custom 8-Pin mini-din cables or expensive S-Video plenum cables are needed and no power outlets are required near the camera bracket. All cabling is routed to the head-end using Cat. 5 cables.

Before Installing

- Locate the camera mounting location paying close attention to camera viewing angles, lighting conditions, possible line of site obstructions, and checking for in-wall obstructions where the camera is to be mounted. Pick a mounting location to optimize the performance of the camera.
- Pre-wire all cabling as required (see wiring diagram examples).
- The Wall Mount for the WallVIEW Z330 can be mounted directly to a 3-gang wall box or can be mounted to the drywall using four dry wall anchors.

Wiring Diagram Example:

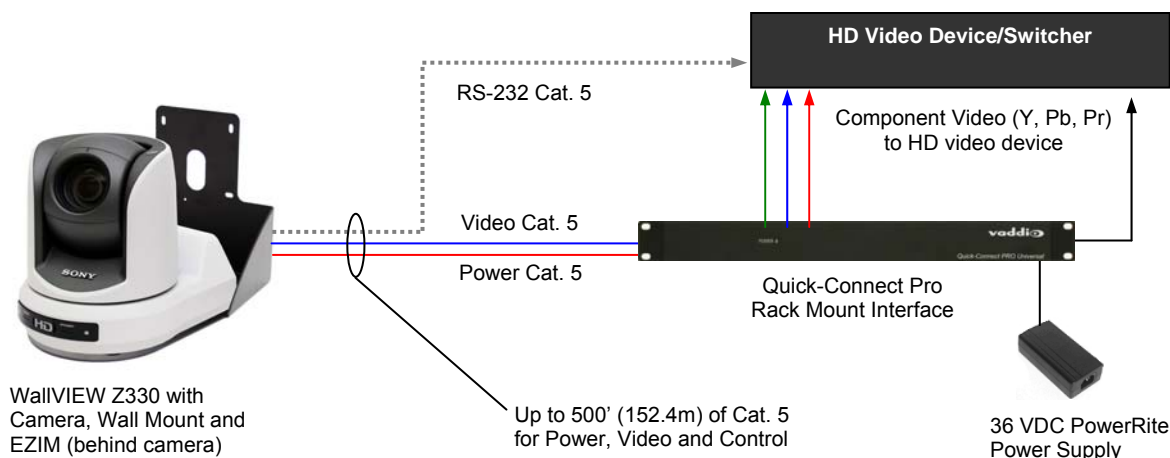

Figure 2: Basic connectivity of the WallVIEW PRO Z330 System.

The WallVIEW PRO Z330 uses a Cat. 5 (all 4-pairs) for power to ensure the direct drive motors receive the required current to operate properly. The Video Cat. 5 uses 3-pairs of the Cat. 5 for Video and 1-pair for IR forwarding. The RS-232 Cat. 5 uses 5 conductors for RS-232 with provision for daisy chain controllers. These Cat. 5 cables can be run up to 500' (152.4m). See Appendix 1 for wiring and pin-out information

Daisy Chain Control Configuration:

The WallVIEW PRO Z330 has provisions for daisy chaining control signals when using a RS-232 controller with only one (1) RS-232 output. Each WallVIEW PRO EZIM has a RS-232 input and a RS-232 output (see Figure 3).



Figure 3: Daisy chain control configuration using two (2) WallVIEW PRO Z330 systems and a single RS-232 output control device. See Appendix 1 for wiring and pin-out information.

MOUNTING INSTRUCTIONS

Step 1:

After determining the optimum location of the camera system, route the required 3 (three) Cat. 5 cables from the camera to the Quick-Connect Pro interface located at the head-end. The three Cat. 5 cables should feed-through the oval slot located on the rear flange of the wall mount (Figure 4). If the bracket is to be mounted on a 3-gang wall box, use the screws supplied with the wall box cover plate to attach the Wall Mount. If mounting to the drywall with wall anchors, use four (4) quality wall anchors. The mounting holes are slotted and are 90° opposing to provide easy leveling. Level the mount and tighten the mounting screws.

Figure 4: Wall Mount with oval cable feed-through hole. The wall mount may be mounted directly to a 3-gang wall box or to the dry wall with the appropriate wall anchors.



Note: Z330 Wall Mount looks slightly different

Step 3:

Connect the 25-pin end of the break out cable to the EZIM. Next, mount the EZIM to the back of the wall mount on the left side, using the two tapped screw holes (see Figure 6). Connect the 15-pin video cable, power connector and 8-pin mini-DIN connectors (VISCA IN is labeled) from the EZIM to the back of the camera.

Figure 5: 25-pin break out cable connected to EZIM (left); EZIM and break out cable installed in Wall Mount (right).



Step 4:

Attach the Cat. 5 cables for Power, Video and Control to the EZIM and feed the excess Cat. 5 cabling into the wall opening or wall box.

Step 5:

Place the camera onto the camera mount and using the 1/4"-20 screw to secure the camera to the mount.

Step 6:

The Quick-Connect PRO is a 1-RU rack mount interface that breaks out the signals from the Cat. 5 cables back to the standard connectors. The basic system connectivity is illustrated in Figure 6.

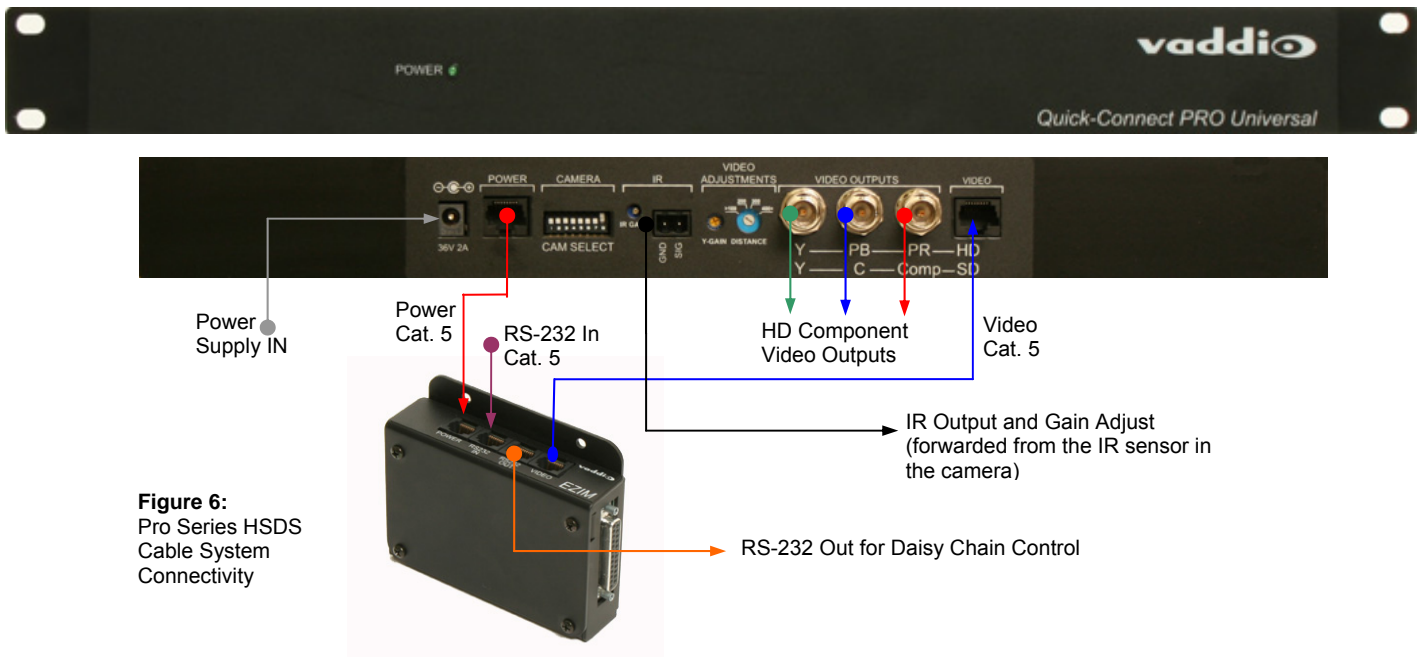

Figure 6:
Pro Series HSDS
Cable System
Connectivity

Step 6 (continued):

Attach the Cat. 5 cables for Power, Video and Control to the Quick-Connect PRO interface. Connect the HD video output BNC connectors. Connect the PowerRite 36 VDC power supply to the Quick-Connect PRO power input. Please check all Cat. 5 cables for continuity in advance of final connection.

Note: Plugging the POWER Cat. 5 Cable into the wrong RJ-45 may cause damage to the camera system and void the warranty.

Step 7:

Connect the Vaddio 36 VDC power supply to an AC outlet. Power will travel down the Power Cat. 5 cable to the cable shoe, powering the camera. The camera will “Home” to a centered position ready for control information from the IR remote control or RS-232 camera controller of the integrators’ choice. To ensure proper continuity of control and operation of the cameras, the RS-232 controller (control system or joystick) should be powered on after the camera.

Step 8: Setting the IR Pass-Through Adjustment (optional)

The PRO system is capable of transmitting IR signal frequencies between 25 to 45 kHz. Connect the IR output from the Quick-Connect PRO to either the IR input on a third party device or a Xantech™ IR probe (compatible models: 282MRP or 283M). See Figure 7 for terminating cable termination of the Xantech probe. NOTE: Vaddio has tested compatibility of the IR forwarding with Sony, Vaddio, Polycom and TANDBERG remote controls.



NOTE: The IR Gain adjustment is factory set for distances below 300 feet (91.4 meters), and should not have to be adjusted unless the Cat. 5 cabling distance is over this length. For cable runs above 300 feet, slowly adjust the gain level up while pressing functions on the remote control, pointed at the Z330 camera using the WallVIEW PRO system. Once all remote control functions are operating from the remote, through the camera’s IR sensor, the IR gain is adjusted properly.

Connecting an IR Probe:

If connecting a Xantech IR Probe to the IR output of the Quick-Connect Pro, the white striped wire on the probe should be connected to the signal “SIG” terminal and the ground, or black wire to “GND”. Attach the probe over the IR window of the codec. Make sure the dipswitch is in the correct position

Figure 7:
Terminating Xantech Probe cable to 2-conductor Phoenix connector

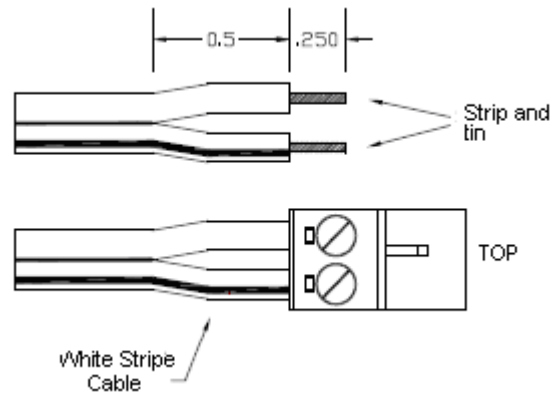

CARE AND CLEANING

- Do not attempt to take the products in these systems apart. There are no user-serviceable components.
- Keep these devices away from food and liquid, and do not spill liquids on the products
- For smears or smudges on the lens, wipe with a clean, soft cloth. Do not use any abrasive chemicals on the camera body at any time.

OPERATING AND STORAGE CONDITIONS

Do not store or operate the WallVIEW PRO System under the following conditions:

- Temperatures above 40°C (104°F) or below 0°C (32°F), for Indoor Use Only
- High humidity, condensing or wet environments
- Dusty environments
- In inclement weather
- Under severe vibration

GENERAL SPECIFICATIONS

WallVIEW PRO Z330 System	
System Part Numbers	999-6855-000 NTSC 999-6855-001 PAL
• Sony BRC-Z330	
Image Device	1/3-type CMOS
Total Picture Elements	2 Megapixels (approximate)
Signal System	1080/59.94i, 1080/50i, 720/59.94p or 720/50p (switchable)
Lens	18x Optical Zoom (72x with digital zoom)
Focal Length	f=4.6 to 82.8mm
Minimum Illumination	6 lux (50 IRE, f1.6, +24 dB)
Horizontal Viewing Angle	3.3 to 55.1 degrees
Video S/N Ratio	50 dB
Pan/Tilt Angle	-175 to +175 degrees (Pan), -30 to +90 degrees (Tilt)
Quick-Connect Interface	
Connectors	Power Connector: 5.5mm OD x 2.5mm ID Power RJ-45: Supplies 36V to EZCamera Interface Module Regulator IR: 2-Pin Phoenix type spring cage connector Video Outputs: BNC Connectors for HD Analog Component (Y,PB,PR) Video RJ-45: Transports HD video from camera
Camera Select Switch	8-Position DIP switch loads camera profiles and IR Forwarding for Polycom and TANDBERG Codecs
Video Adjustments	Y-Gain (luminance gain) for fine tuning over longer cable distances Distance Compensation: 100', 200', 300', 400'+
Compatible Cameras	Sony BRC-H700, BRC-Z330, BRC-Z700, EVI-HD1, BRC-300, Polycom EagleEye
Max. Cat. 5 Cable Distance	Up to 500' (152.4m) for Video Power and Control
Power Supply	36 VDC, 2.78 Amp
Dimensions	1-RU Rack Mount (1.75" H x 19" W x 6" D)
Connectors	Four (4) RJ-45 Connectors One DB-25 for Power, Video, Control & IR
Cable Assemblies	For Sony HD Cameras: DB-25M to DB-15HD/8-Pin Mini Din x 2/EIAJ4 Power Connector
Power Regulator	Supplies 12VDC to Cameras
Dimensions	Approx. (3.035" H x 4.46" W x 1.242" D)
• Wall Mount Z330	
Materials	12-Gauge CRS with Black Powder Coat Paint
Dimensions	8" H x 8.5" W x 11.875" D (20.3 cm x 21.6 cm x 30.2 cm)
Weight	Approx. 4.5 lbs. (2 kg)

Appendix 1: Cable Pin-outs for the WallVIEW PRO System

EZCamera Interface Module Pin-outs

Power Connector

Pin	Signal
1	Power +
2	Power -
3	Power +
4	Power -
5	Power +
6	Power -
7	Power +
8	Power -

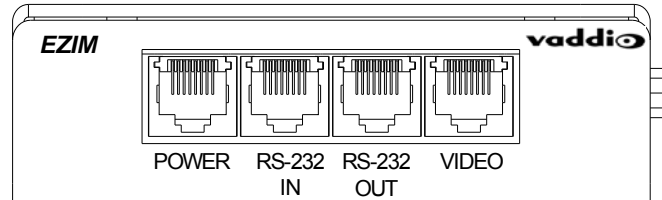

RS-232 IN Connector

Pin	Signal
1)	DTR (Sony® Daisy chain to DSR)
2)	DSR (Sony Daisy chain from DTR)
3)	Unused
4)	Unused
5)	Unused
6)	Digital GND
7)	RXD (from TXD of control source)
8)	TXD (to RXD of control source)

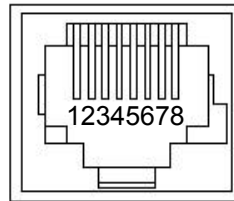

RS-232 OUT Connector

Pin	Signal
1)	DSR (Sony Daisy chain from DTR)
2)	DTR (Sony Daisy chain to DSR)
3)	Unused
4)	Unused
5)	Unused
6)	Digital GND
7)	TXD (to RXD of control source)
8)	RXD (from TXD of control source)

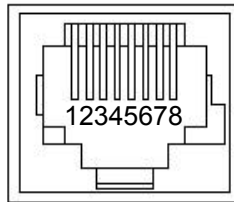

Video Connector

Pin	Signal	SD	HD
1)	IR+	IR+	IR+
2)	IR GND	IR GND	IR GND
3)	Y+	Y+	Y+
4)	C+	PB+	PB+
5)	C-	PB-	PB-
6)	Y-	Y-	Y-
7)	Comp. Video +	PR+	PR+
8)	Comp. Video -	PR-	PR-

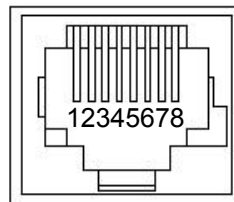

EZCamera Interface Module Pin-outs (continued)

DB-25 Connector

Pins	Signal
1	GND Out
14	RXD Out
2	TXD Out
15	DTR Out
3	DSR Out
16	GND IN
4	TXD IN
17	RXD IN
5	DTR IN
18	DSR IN
6	IR
19	GND
7	GND
20	CVBS/PR
8	GND
21	C/PB
9	GND
22	Y/Y
10	GND
23	GND
11	GND
24	12V
12	12V
25	12V
13	12V

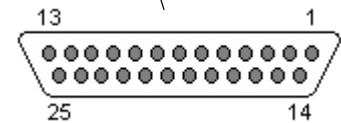
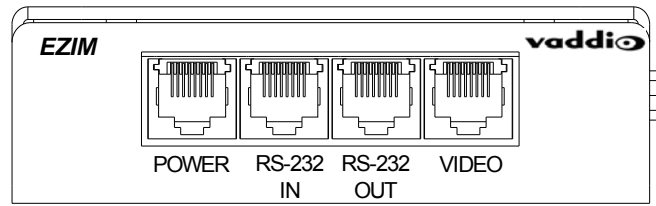

Quick-Connect Pin-outs

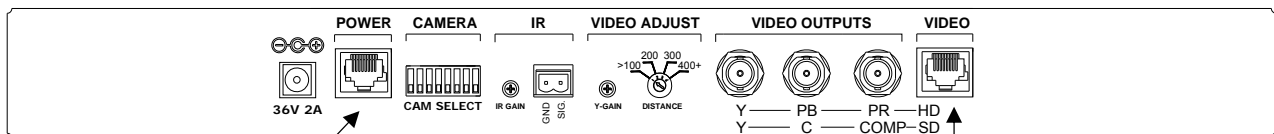

Power Connector

Pin	Signal
1	Power +
2	Power -
3	Power +
4	Power -
5	Power +
6	Power -
7	Power +
8	Power -

Video Connector

Pin	Signal	SD	HD
1)	IR+		IR+
2)	IR GND		IR GND
3)	Y+		Y+
4)	C+		PB+
5)	C-		PB-
6)	Y-		Y-
7)	Comp. Video +		PR+
8)	Comp. Video -		PR-

Sony HD & SD Camera Control Pin-outs

RS-232 IN Connector (8-Pin Mini Din)

Pin	Signal
1	DTR
2	DSR
3	TXD
4	GND
5	RXD
6	GND
7	IR OUT
8	Unused

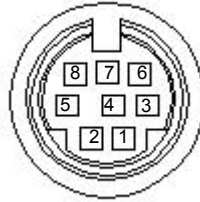

RS-232 IN Connector (8-Pin Mini Din)

Pin	Signal
1	DTR
2	DSR
3	TXD
4	GND
5	RXD
6	GND
7	Unused
8	Unused

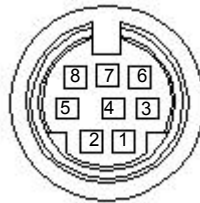

Sony HD Video (analog component) Pin-outs Video Output Connector (DB-15HD)

Pin	Signal
1	PR
2	Y
3	PB
4	GND
5	GND
6	GND
7	Unused
8	Unused
9	NC
10	Unused
11	Unused
12	Unused
13	Unused
14	Unused
15	Unused

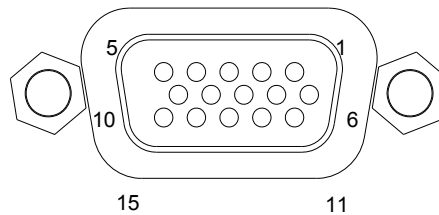

FCC, ICES-003 Compliance and CE Declaration of Conformity

For Vaddio Quick-Connect PRO and EZIM Products



FCC Part 15 Compliance

This equipment has been tested and found to comply with the limits for a Class A digital device, pursuant to Part 15 of the FCC Rules. These limits are designed to provide reasonable protection against harmful interference when the equipment is operated in a commercial environment. This equipment generates, uses, and can radiate radio frequency energy and, if not installed and used in accordance with the instruction manual, may cause harmful interference to radio communications. Operation of this equipment in a residential area is likely to cause harmful interference in which case the user will be required to correct the interference at his/her own expense.

Operation is subject to the following two conditions: (1) This device may not cause interference, and (2) This device must accept any interference including interference that may cause undesired operation of the device.

Changes or modifications not expressly approved by Vaddio can affect emission compliance and could void the user's authority to operate this equipment.



ICES-003 Compliance

This digital apparatus does not exceed the Class A limits for radio noise emissions from digital apparatus set out in the Radio Interference Regulations of the Canadian Department of Communications.

Le présent appareil numérique n'émet pas de bruits radioélectriques dépassant les limites applicables aux appareils numériques de la classe A prescrites dans le Règlement sur le brouillage radioélectrique édicté par le ministère des Communications du Canada.



European Compliance

This product has been evaluated for Electromagnetic Compatibility under the standards for Emissions and Immunity and meets the requirements for E4 environment. This product complies with Class A (E4 environment). In a domestic environment this product may cause radio interference in which case the user may be required to take adequate measures.

Standard(s) To Which Conformity Is Declared:

EMC Directive 89/336/EEC

EN 55022A	Conducted and Radiated Emissions
EN 55024	Electromagnetic Compatibility - Immunity
EN 61000-4-2	Electrostatic Discharge Requirements
EN 61000-4-3	Radiated Electromagnetic Field Requirement
EN 61000-4-4	Electrical Fast Transients / Burst Requirements
EN 61000-4-5	Surge Requirements
EN 61000-4-6	Conducted Immunity Requirements
EN 61000-4-8	Power Frequency Magnetic Field Requirements
EN 61000-4-11	Voltage Dips, Interrupts and Fluctuations Requirements



WARRANTY INFORMATION

Hardware* Warranty - One year limited warranty on all parts. Vaddio warrants this product against defects in materials and workmanship for a period of one year from the day of purchase from Vaddio. If Vaddio receives notice of such defects during the warranty period, they will, at their option, repair or replace products that prove to be defective.

Exclusions - The above warranty shall not apply to defects resulting from: improper or inadequate maintenance by the customer, customer applied software or interfacing, unauthorized modifications or misuse, operation outside the normal environmental specifications for the product, use of the incorrect power supply, improper extension of the power supply cable or improper site operation and maintenance.

Vaddio Customer service – Vaddio will test, repair, or replace the product or products without charge if the unit is under warranty and is found to be defective. If the product is out of warranty, Vaddio will test then repair the product or products. The cost of parts and labor charge will be estimated by a technician and confirmed by the customer prior to repair. All components must be returned for testing as a complete unit. Vaddio will not accept responsibility for shipment after it has left the premises.

Vaddio Technical support - Vaddio technicians will determine and discuss with the customer the criteria for repair costs and/or replacement. Vaddio Technical Support can be contacted through one of the following resources: e-mail support at support@vaddio.com or online at www.vaddio.com.

Return Material Authorization (RMA) number - Before returning a product for repair or replacement, request an RMA from Vaddio's technical support. Provide a technician with a return phone number, e-mail address, shipping address, and product serial numbers and describe the reason for repairs or returns as well as the date of purchase and proof of purchase. Include your assigned RMA number in all correspondence with Vaddio. Write your assigned RMA number on the shipping label of the box when returning the product. Please see Vaddio's website for current RMA policies and procedures.

Voided warranty – The warranty does not apply if the original serial number has been removed or if the product has been disassembled or damaged through misuse, accident, modifications, or unauthorized repair. Cutting the power supply cable on the secondary side (low voltage side) to extend the power to the device (camera or controller) voids the warranty for that device.

Shipping and handling - Vaddio will not pay for inbound shipping transportation or insurance charges or accept any responsibility for laws and ordinances from inbound transit. Vaddio will pay for outbound shipping, transportation, and insurance charges for all items under warranty but will not assume responsibility for loss and/or damage by the outbound freight carrier. If the return shipment appears damaged, retain the original boxes and packing material for inspection by the carrier. Contact your carrier immediately.

Products not under warranty - Payment arrangements are required before outbound shipment for all out of warranty products.

*Vaddio manufactures its hardware products from parts and components that are new or equivalent to new in accordance with industry standard practices.



9433 Science Center Drive, Minneapolis, MN 55428
Toll Free: 800-572-2011 ▪ Phone: 763-971-4400 ▪ FAX: 763-971-4464
www.vaddio.com

©2009 Vaddio - All Rights Reserved. Reproduction in whole or in part without written permission is prohibited. Specifications and pricing subject to change. Vaddio, WallVIEW, Quick-Connect, EZIM, HSDS and PowerRite are registered trademarks of Vaddio. All other trademarks are property of their respective owners. Document Number 341-907 Rev. A